



*"Training for the professional technician"*

**AD-500**

**Advanced Computer  
Diagnostics**

**CARQUEST  
Supports**



# *Advanced* Computer Diagnostics

**NOTES:**

---

---

---

---

---

***Beginning Fault Pattern  
Recognition***

**Engine Management Systems**

**OR**

**Fuel and Ignition**

**System Management**

*Fault Pattern Recognition* helps lead the technician to the sub-system which will require further testing. The emphasis of this course is on the PCM's management of the fuel and ignition systems.

4

The first vehicle we will look at is a 1991 Ford Taurus with a fast idle complaint. As the diagnostic technician, what do you want to do first?

***Fault Pattern Recognition***

- Vehicle: 1991 Ford Taurus  
Complaint: Idle too fast - 1450 RPM
  
- As the technician, what do you want to do first?

5

***Fault Pattern Recognition***

- Vacuum Leak?
- Throttle Position Sensor?
- Idle Air Control?
- Scan Data?

Do you want to check for vacuum leaks? Should you check the adjustment of the TPS? Will you look at scan-data first? Regardless of the problem there must always be a starting point to your diagnosis.

6

**NOTES:**

---

---

---

---

---

THINK! Before you do anything, engage your brain. Ask yourself, "What strategy does the PCM use to control idle speed?"

## ENGAGE BRAIN FIRST

What Strategy does the computer use for Idle control?

7

### *Idle Speed Control Strategy*

- Engine has idled for a period of time *Enrichen*
- Neutral Safety Switch *Change Strategy*
- Engine Temperature too high *Increase Idle*
- Inlet Air Temperature below 100 f *Warm up mode*
- Power Steering Pressure Switch
- Air Condition Switch
- *What would be another reason?*

8

The PCM on this vehicle uses many different inputs to determine the correct idle speed. Besides the items listed, is there anything else that could effect idle speed?

A battery with a low state of charge could effect the idle speed. The PCM increases idle speed to turn the alternator faster to increase the charging rate. But, other changes are made by the PCM to correct for a low battery. Why?

### *Low Battery*

- Low Battery Correction
- The PCM increases idle speed (increasing charging rate).
- The PCM increases dwell time (coil saturation).
- The PCM modifies the injector pulse width by a programmed-in correction factor.
- *Why?*

9

### NOTES:

---

---

---

---

---

## *Low Battery*

- If battery voltage drops, the fuel pumps slow down, and fuel volume is decreased

Because other items are affected by a low battery such as fuel pump speed.

10

Diagnosis is the basis of driveability repair.

## *Diagnostics*

*(Advanced or Otherwise)*

Diagnose \ˈdi-ig-nos 1859 to recognize (as a disease) by sign or symptoms

To diagnose a condition

To analyze the cause or nature of a problem

To make a diagnosis

The act of identifying from signs and symptoms

To make a decision reached by diagnosis (Based on information)

A concise technical description of a Taxon (Scientific classification)

Investigation or analysis of the cause or condition, a situation

Statement or conclusion from analysis

Using a methods of yielding an answer

11

## *Engine Management Systems*

- Fuel must be metered into the engine for all engine operating conditions
- Anything that effects fuel effects timing
  - Cold engine:
    - Start up
    - Idle
    - Drive off
    - Acceleration
    - Cruise
    - Deceleration
  - Hot engine:
    - Hot re-start
    - Idle
    - Drive off
    - Acceleration
    - Cruise
    - Deceleration

12

The PCM must control the delivery of fuel into the combustion chamber for all operating conditions. Any change in fuel management will also have a corresponding change in ignition timing management.

### **NOTES:**

On Cold Start should have about 10 Times  
Normal Idle Pulse Width Upwards at  
100 MS

Key to acceleration is a Change in Air  
fuel ratio

The goal of this training course is to provide you with enough information to recognize fault patterns. This alone will be enough to greatly reduce your diagnostic time.

**Objectives**

- The scope of this training course is to provide you with enough information about Engine Management Systems to be able to **Recognize Fault Patterns**
- Common failures will also be covered

13

**Objectives**

- Understanding a circuit and how it works is not the only thing we need to concern ourselves with.
- In diagnostics, we always want to find the **Root Cause** of the Driveability complaint
- Diagnosing and repairing symptoms will only lead to come-backs.

14

Vehicle system theory is not the only thing to be concerned with when confronted with a driveability problem. System strategy and fault pattern recognition will help lead to the root cause of the driveability complaint. Diagnosis by symptom will only lead to comebacks.

Fords use different operation strategies than GMs and Chryslers and vice versa, Like the vehicles themselves, this course is not generic.

**Course Material**

- Fords are not Chryslers
- Chryslers are not General Motors
- General Motors are not Fords
- Ford are not General Motors
- General Motors are not Chryslers
- Chryslers are not Fords
- Fords are not .....
- Got The Idea?
- This course is not Generic!

15

**NOTES:**

Bauds rate  
= Bits per second      So      180 bits per seconds

## Scan-Tool

- Data — Live and Recorded
- Out-Put Status
- Solenoid Status

Why do we use a scan-tool? We can use a scan-tool to look at data, either live or recorded, view output status and on some vehicles even solenoid status. Scan data is not the best source of diagnostic data because of its relative slow speed, but it is the easiest way to gather a lot of information quickly.

16

During open loop, the PCM reads the inputs and makes output command decisions based on these inputs and on programming.

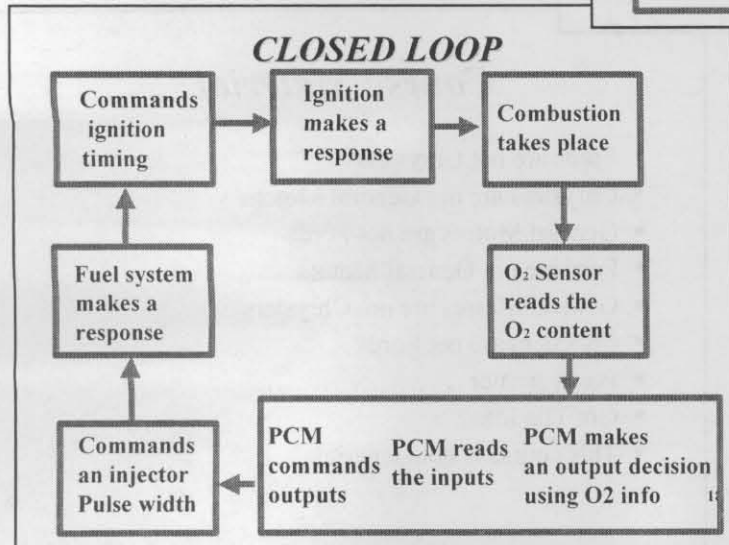
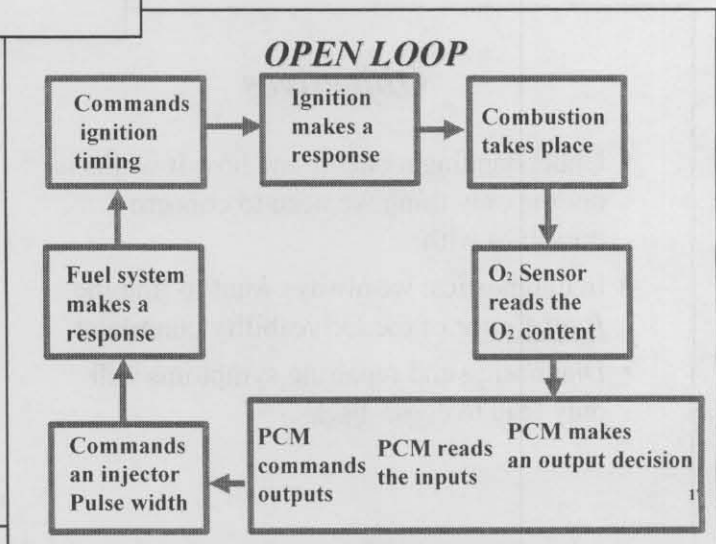

During Closed Loop the same holds true, except the PCM now relies on the input of the oxygen sensor to make these command decisions.

### NOTES:

---



---



---



---

The easiest way to determine when the system enters closed loop, is to use a scan-tool. You can also watch the oxygen sensor on a lab-scope. If the vehicle uses a secondary air injection system, watch the voltage on the ground side of the diverter valve. It will drop below one volt when activated in closed loop.

### *Testing for Closed Loop*

- The easiest way is to watch the scan-tool
- Watch the oxygen sensor with a DSO
- Measure voltage on the ground side of the diverter valve. (Should go under 1 volt if the PCM closes loop)

19

### *Idle?*

- Idle Speed Control Strategy:
- Engine has idled for a period of time
- What else would the PCM do beside increase Idle?

The PCM can make other adjustments to control or compensate for idle speed. If a vehicle has idled for an extended period of time, what else could the PCM do besides increase idle speed?

One thing is to increase injector

21

pulse width, another is to retard ignition timing.

### *Idle Speed Control Strategy*

- Increase Injector Pulse Width (To Cool the Cylinders)
- Retard Ignition Timing

22

### **NOTES:**

---

---

---

---

---



### ***Idle Speed Control Strategy***

- Engine has idled for a period of time
- Neutral Safety Switch
- Engine Temperature raises above normal range
- Inlet Air Temperature below 100° F
- Power Steering Pressure Switch
- Air Condition Switch
- Battery Voltage Low

23

Here are some of the various inputs the PCM uses for idle speed control strategy.

What is different about GM's idle speed control strategy? It will only control idle speed within a specific window of battery voltage, 10.9-15.1 volts. If battery voltage is not within this window, idle speed will remain fixed. Engine speed and load are the

### ***Idle Speed Control Strategy***

- What is different about a G.M.'s Idle Speed Control Strategy?
- If Battery Voltage is not between 10.9v and 15.1v the PCM **Idle Speed is Fixed**

24

### ***Fuel Control Strategy***

- RPM and MAP, VAF or MAF are used by the computer to determine the injector pulse width.
- The injector pulse width is then modified based upon the inputs
- The PCM will enrich the air / fuel charge if...

25

major inputs used by the PCM to determine the correct injector pulse width command.

### **NOTES:**

---

---

---

---

---

The PCM will enrich the air/fuel charge based on the inputs listed here.

### *Fuel Control Strategy*

- Barometric Pressure increases
- Engine is Cold or Above normal Temperature
- TPS Value Changes
- EGR flow changes
- O2 Reports low voltage
- Inlet Air Temperature is low
- Engine Load Increases

26

### *Ignition Timing Control Strategy*

- The PCM will advance ignition timing for:
  - Acceleration Mode
  - Engine is cold
  - Air Inlet Temperature Cold
  - EGR Flow increases
  - Manifold Pressure increases
- The PCM will Retard ignition timing for:
  - Deceleration Mode
  - Engine warms up
  - IAT warms up
  - EGR Flow decreases
  - Manifold Pressure decreases

27

In very much the same way the PCM controls fuel, it also controls ignition timing based on various inputs.

When the ignition key is turned on, the PCM sends a state of health message and talks to its inputs and determines if it can use those inputs for fuel and timing control.

### *Operating Modes*

- Key "ON": When the ignition is turned to the "on" position the PCM receives the signal:
- The PCM Sends a State of health Message:

28

### **NOTES:**

---

---

---

---

---

## *Operating Modes*

- The PCM then listens to the answer from the main Inputs
- MAP for Barometric Pressure
- ECT for Choke Position
- TPS for Clear Flood
- And Stores this information

29

Once the PCM receives answers from its "wake-up" call, it stores this information for use during cold start, hot restart etc.

There are numerous operating modes for which the PCM has to make adjustments. The key here is that the operating modes change.

## *Operating Modes*

- Cold Start (Cranking)
- Cold Acceleration
- Cold Cruise
- Cold Deceleration
- Hot Re-Start (Cranking)
- Warm Acceleration
- Warm Cruise
- Warm Deceleration

30

## *Adaptive Learning Mode*

- The Oxygen Sensor goes too rich for too long
- The PCM begins to subtract fuel from the fuel control program
- The Oxygen Sensor returns to reporting Fuel Control
- The PCM stops adding fuel

31

The PCM also has the ability to adapt for problems. This adaptive learning mode makes it possible for the vehicle to mask *minor* driveability problems.

## **NOTES:**

---

---

---

---

---

These corrections are stored in the PCM's memory for the next time the engine is run. The PCM has a power supply when the ignition is off to retain this memory so the relearn procedure does not have to be repeated.

### *Adaptive Learning Mode*

- The PCM records the amount of fuel decrease in the fuel cell
- The PCM has a power supply when the ignition is off and the power keeps the memory active, so that the PCM will not have to go through the learning process again

32

### *Operating Mode to Handle Failures*

- FORD: Failure Mode Effect Management (FMEM)
- If, through self testing the PCM recognizes an input that can "not be real", the PCM goes into FMEM.
- The PCM replaces the faulty reading with a calculated value based on the inputs that the PCM still considers accurate.

Some PCMs have the ability to correct for input failures. The PCM accomplishes this by learning what the correct values should be during normal driving. When a component fails, a calculated value replaces the failed input. Ford calls this FMEM. Ford has several "test modes" to

33

help find input and output failures. Key-on/engine-off, key-on/engine-running, computed timing test and wiggle test are some of these test modes.

### *Operating Mode to Handle Failures*

- Ford's Self Test Modes
  - K-O-E-O
  - K-O-E-R
  - Computed Timing Check
  - Wiggle Test

34

NOTES: HLOS runs on RPM and TPS only

a i P 4  
 d m v 3  
 w t a t  
 e t t m  
 r d g

### ***Operating Mode to Handle Failures***

- Chrysler: Uses a Default program to handle inputs it considers to be “not real”
- Example: The PCM sees -40° F from the ECT and the engine has been running for 10 minutes
- The Charge Temperature Sensor indicates 80° F
- The PCM Determines that the ECT must be wrong

35

Chrysler uses a default instead of a calculated value, when it determines one of its inputs has failed. If, for instance, the PCM determines the coolant temperature sensor is no longer supplying a believable input value, the PCM will run off of a default value.

This value will be either 104°F or 114°F depending on the processor calibration. This temperature is meant to be a middle of the road value for all operating conditions.

### ***Operating Mode to Handle Failures***

- THE PCM: Defaults the ECT to 104°F-114°F (A middle of the road value)
- When the PCM is in default the fuel and ignition programs are change to reflect the default

36

### ***Operating Mode to Handle Failures***

- Testing Vehicles that are in:
  - “Limp-In”
  - “Default”
  - “FMEM”
- May present a problem

37

When a vehicle is running in default mode, the fuel and ignition timing programs are modified to reflect the default. Attempting to diagnose a vehicle in default or limp-in mode will present a problem.

### **NOTES:**

---

---

---

---

---

When using a scan-tool for diagnostics, it is up to you, the technician, to determine if the data being reported is good or bad, the truth or a lie.

### *Scan-Tool Diagnostics*

- Data — Live and Recorded
- When looking at Data, Look for:
  - GOOD
  - BAD
  - TRUTH
  - LIE

38

### *GOOD*

- Information from the computer's Data stream comes in different values
  - Voltage
  - Frequency
  - Inches of Vacuum
  - Inches of Mercury
  - Grams Per Second

39

Information in scan-data can be displayed in several forms such as: voltage, frequency, inches of vacuum or mercury and grams per second.

In order for the values to be considered good, they must fall within the vehicle specific parameters for the operating conditions.

### *Parameters*

- A value must within certain Parameters to be considered Good
- An Example:
  - TPS Voltage @ Idle .5v to .8v
  - If the throttle closed value is within the specifications it is Good

40

### **NOTES:**

---

---

---

---

---

### *Bad*

- If the value is not within specifications it is Bad
- This is where a technician begins to diagnose because there is more than one reason that will make it bad
- You only know it is not within specifications

41

If the value displayed is not within specification, it is considered bad. This is the point at which the technician begins to diagnose. There can be multiple possibilities why the value is out of specification.

A data value that is representing the actual operating conditions is considered to be the truth. Data does not have to be good to be the truth.

### *Truth*

- A value that is representing the actual condition is the Truth
- Data that is showing the engine vacuum to be low may not be Good...
- But if the engine in fact has low vacuum the Data is the Truth

42

### *Lie*

- A value that is not representing the actual condition is a Lie
- Data that is showing the engine vacuum to be low may not be Good...
- But if the engine *does not* have low vacuum the Data is a Lie

43

A data value that is not representing the actual operating conditions is considered to be a lie. For instance if the scan-data displays an engine vacuum of 18"hg, this may be good; but if engine vacuum on a gauge is actually 15" hg the data is a lie.

### NOTES:

---

---

---

---

When you read data on a scan-tool, keep in mind where the data comes from. In the case of engine vacuum, the PCM, the sensor, connector, wiring, vacuum hose, and actual engine vacuum are all parts of creating the data.

### *Manifold Absolute Pressure Sensor*

- Specification @ Idle 1.4v to 1.6v
- This indicates 19 to 21 inches of vacuum
- The PCM, Sensor, Wires, Vacuum Hose and actual engine vacuum all go into creating this Data

44

### *Manifold Absolute Pressure Sensor*

<u>Actual Vacuum</u>	<u>MAP Volts</u>	<u>Condition</u>
20"	1.5v	Good/Truth
15"	1.5v	Good/Lie
20"	1.0v	Bad/Lie
15"	2.0v	Bad/Truth

Listed here are some combinations of Good/Bad, Truth/Lie.

45

Here is scan-data from a Chrysler vehicle at idle. Actual engine vacuum is 21" hg. Do you see any incorrect data?

### *Interpreting Scan Data*

- This is a Chrysler @ Idle with 21"Hg of engine vacuum
- *Do you see any incorrect Data?*

<u>RPM</u>	<u>MAP</u>	<u>MAPV</u>	<u>TPS</u>
850	10	1.4	.9
<u>O2</u>	<u>ECT</u>	<u>LTFT</u>	<u>IPW</u>
.3	190	09	3.3

46

#### **NOTES:**

*Vacume = Baro - minus MAP.*



### *Interpreting Scan Data*

- The previous side showed MAP to be 1.4v
- If you were on a Chrysler that voltage would be incorrect.
- The specification is .9 to 1.1v
- 1.4v may be correct on other Vehicles

47

If not, it is likely due to the fact that you do not have the parameters for the vehicle. Although many GM vehicles normally have a MAP voltage of 1.4 volts, the correct reading for this Chrysler is .9-1.1 volts.

When interpreting scan-data, vehicle specific parameters are critical. Just look at the differences in closed throttle TPS values on these different vehicles.

### *Vehicle Specific Information*

- When interpreting DATA *Vehicle Specific* data is very important
- Closed throttle TPS voltage:
  - Ford — .8 to 1.2 Volts
  - G.M. — .2 to 1.5 Volts
  - Chrysler — .6 to .8 Volts

48

### *Verify the Scan-Data*

- Look for other indicators that will verify that the condition exist
- If you were looking at the MAP signal RPM would help verify that engine vacuum did in fact change
  - MAP Voltage is a result of changes in engine load
  - RPM is a result of the engine physically rotating
- If one changes the other must reflect that changing condition

49

When attempting to verify scan-data, look for indications that the condition actually exists. Look for a reflection of changing data in other data values. For instance, if MAP voltage is changing does RPM or TPS change as well?

### **NOTES:**

---

---

---

---

When viewing MAP on a scan-tool, vacuum and/or pressure can be displayed. Manifold pressure is the opposite of vacuum. As vacuum decreases, pressure increases.

### Verify the Scan-Data

- Key-on/Engine-off the *pressure* is at it's highest value....*vacuum* is at it's lowest (Zero)
- Engine at *Idle* the pressure is at it's lowest value....*Vacuum* is at it's highest
- When the throttle is opened the *pressure* in the manifold raises and the *vacuum* lowers

50

### Verify the Scan-Data

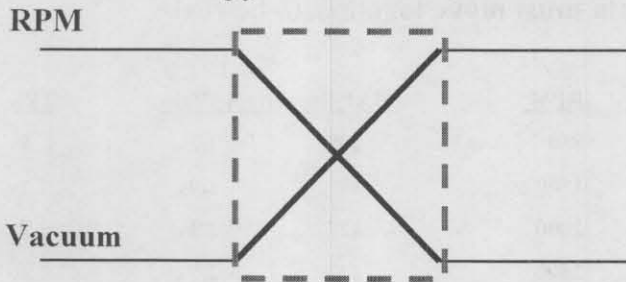

They, both must reflect the changing condition in the same time frame

51

RPM and vacuum must reflect the changing conditions. As RPM (under load) decreases, vacuum increases.

As RPM (under load) increases, vacuum decreases.

### Verify the Scan-Data

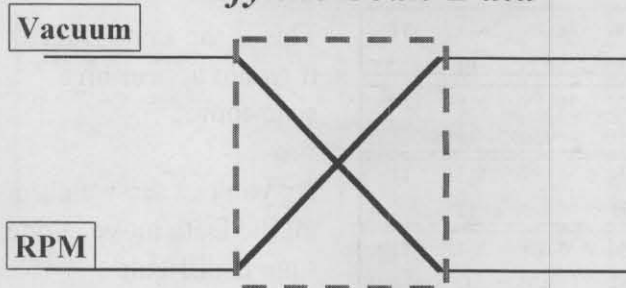

They, both must reflect the changing condition in the same time frame

52

### NOTES:

---



---



---



---



---

**Data must move together to be real**

<u>RPM</u>	<u>MAP Pressure/Voltage</u>		<u>Vacuum</u>
850	10"	1.2v	18"
1500	11"	1.9v	17"
2000	12"	2.3v	16"
2500	13"	2.7v	15"
3000	14"	3.2v	14"

54

Data values must change together in order to be considered real. RPM, MAP pressure, and MAP voltage must move together. A vacuum gauge can be used to verify the MAP change.

The TPS values can also be used to verify a change. When RPM increases and MAP pressure decreases, the TPS must have changed to produce these results.

**Data must move together to be real**

<u>RPM</u>	<u>MAP Pressure/Voltage</u>		<u>TPS</u>
850	10"	1.2 v	.8v
1500	11"	1.9 v	1.2v
2000	12"	2.3 v	1.8v
2500	13"	2.7 v	2.4v
3000	14"	3.2 v	2.6v

55

**Data must move together to be real**

<u>RPM</u>	<u>MAPV</u>	<u>MAP</u>	<u>TPS</u>
850	1.2V	10"	.8V
1500	1.9V	11"	1.2V
2000	2.3V	12"	1.8V
2500	2.7V	13"	2.4V
3000	3.2V	14"	2.6V

This is the same Data as it would appear on a scan-tool

As you can see watching all the Data move at one time is difficult

56

Here is scan-data as it would appear on a scan-tool. Even with just four bits of data watching, all the values at once can be difficult. In this example, as TPS increases so does RPM. As a result, MAP pressure and voltage increase as well.

**NOTES:**

---



---



---



---



---

In this example, as TPS increases so does RPM, but the change in MAP does not reflect the TPS and RPM change. Can engine manifold pressure change that fast?

**Data must move together to be real**

RPM	MAPV	MAP	TPS
850	1.2V	10"	.8V
1500	3.9V	25"	1.2V
2000	4.6V	29"	1.8V
2500	4.6V	29"	2.4V
3000	4.6V	29"	2.6V

The TPS voltage moved as same as the last slide, but the MAP voltage and MAP inches jumped ahead

Can the engine Change pressure that fast?

57

**Verify the Scan-Data**

- If engine pressure cannot change that fast... why did the **DATA** indicate that it did?
- The change in the electrical signal is what made the DATA create the change shown

Then why did the data say it did? The *signal* from the MAP changed, not the actual condition.

58

Always question if the condition is normal. For instance, scan-data indicates that engine speed is at 5500 RPM. What would cause this to be normal?

**Verify the Scan-Data**

- Question if the condition is normal?
- Engine RPM indicates 5500 RPM
- What could cause this to be normal?

59

**NOTES:**

---



---



---



---



---

### *Verify the Scan-Data*

- **A Wide Open Throttle**
- What would make this abnormal?

A wide open throttle.

What would cause this to be abnormal?

60

A closed throttle.

Data must be *studied* and not just *looked at*.

### *Verify the Scan-Data*

- **A Closed Throttle**
- Data must be **Studied** and not just **Looked at**

61

### *Verify the Scan-Data*

- What other signals would YOU compare RPM to?
  - Throttle Position
  - Absolute Manifold Pressure
  - Oxygen Sensor
  - Mass Air Flow
  - Vane Air Flow

What other data values would you compare to RPM?

62

### **NOTES:**

---

---

---

---

---

Engine vacuum responds opposite to RPM.

## What Signal Responds the Opposite to RPM? Engine Vacuum

63

### *Verify the Condition*

- Look for other indicators that will verify that the condition exist
- If you were looking at the MAP signal, RPM would help verify that engine Vacuum did in fact change
- MAP Voltage is a result of changes in engine load
- RPM is a result of the engine physically rotating
- If one changes the other must reflect that changing condition

64

Look for other indicators that the problem really exists.

What does this scan-data tell you?

<u>RPM</u>	<u>TPS</u>	<u>MAP</u>	<u>IAC</u>
975	.3v	11	07
<u>IPW</u>	<u>BLM</u>	<u>O2</u>	<u>ECT</u>
1.8	137	.7v	197

What does the DATA tell You?

69

### **NOTES:**

---

---

---

---

---

<u>RPM</u> 975	<u>TPS</u> .3v	<u>MAP</u> 11	<u>IAC</u> 07
<u>IPW</u> 1.8	<u>BLM</u> 137	<u>O<sub>2</sub></u> .7v	<u>ECT</u> 197

Focusing on RPM, TPS, and IAC;  
What does the DATA tell you?

70

Now, focusing on these three data bits, what does the data tell you?

Based on the graphed scan-data in the presentation, what must have taken place in order for the additional fuel to be delivered?

*What must have taken place for the additional fuel to be delivered?*

- The TPS signal was sent
- The PCM read the signal correctly
- The PCM computed the rest of the inputs
- The computer command the correct IPW
- The fuel system delivered the fuel
- The engine was able to convert the fuel to RPM
- The RPM signal responded to the change
- The PCM read the RPM signal correctly

72

### *Fault Pattern Recognition*

- 1998 Dodge Mini-Van 3.0L
- Complaint:
  - With Cruise set the vehicle would hesitate then accelerate,
- On its own

74

This vehicle, a 1998 Dodge 3.0L mini-van, would hesitate and then accelerate on its own with the cruise control set.

### NOTES:

---



---



---



---



---

Graphing is a powerful tool for finding intermittent problems. With the correct tools, scan-data, multi-meter and gas analyzer data can be graphed.

## Graphing

- Graphing is a great tool for intermittent failures
- Graph
  - Scan-Tool Data
  - DMM
  - 5-Gas Readings

77

## Graphing

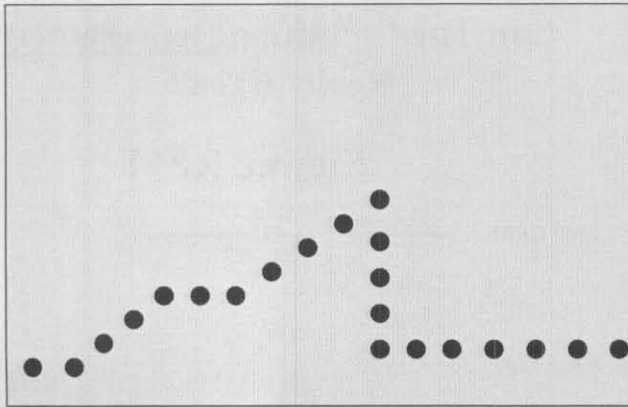

78

A graphing multi-meter takes individual data points and plays connect-the-dots to form a graph of the data over time.

The resulting data appears similar to a waveform. But make no mistake, graphing multi-meters ARE NOT lab-scopes.

## Graphing

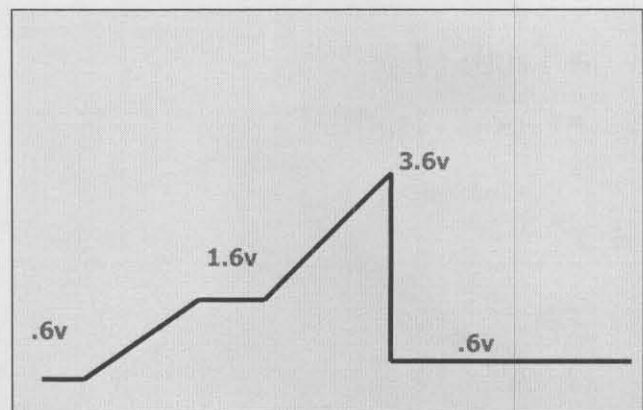

79

## NOTES:

---

---

---

---

---



## Graphing

### Sample Rate

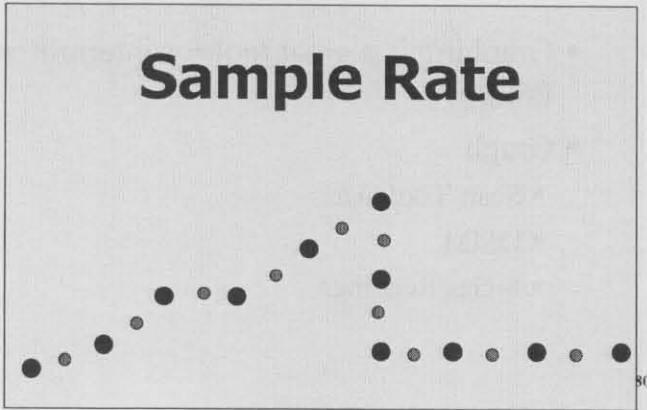

The accuracy of the graph is determined by the sample speed, or how many times the tool samples per second. Most graphing multi-meters sample at a rate of a few thousand times per second. While this may seem fast, even the most basic lab-scope samples at a few million times per second.

There are certain rules to adhere to when graphing. Ask yourself, "Can the condition represented really exist?"

## Graphing Rules

### Can The Condition Represented Really Exist?

#### Engine RPM

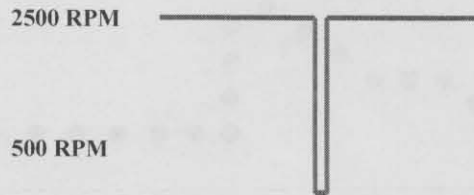

## Graphing Rules

- Truth / Lie
- Good / Bad

As with scan-data, is the value represented good or bad, the truth or a lie?

## NOTES:

---

---

---

---

---

When working with specifications, always attempt to determine the best value. When the specification calls for 0-5, what would be *the best* reading?

### Specifications

- Value 0 to 5
- What is the Best Reading?
- **2.5**

83

### Specifications

- MAP Sensor Voltage
- Spec. 1.2v To 1.6v
- What is the difference between 1.2 and 1.6?

If a MAP sensor being tested has a specification of 1.2 volts - 1.6 volts, what would be the ideal value?

84

What could cause the pattern displayed to appear as it does?

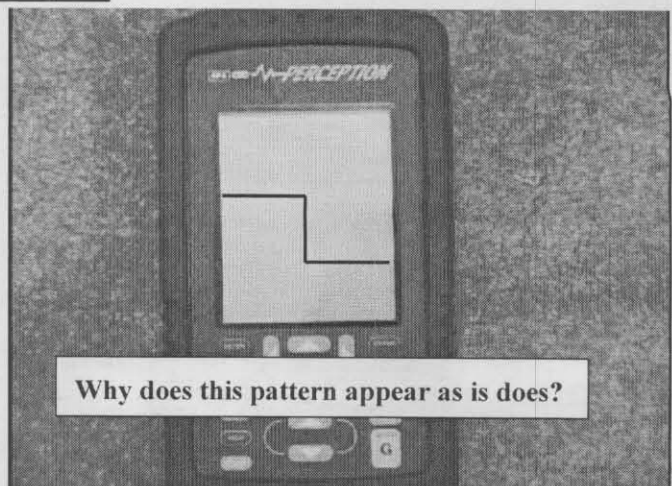

Why does this pattern appear as is does?

### NOTES:

MPC Publishing

800-733-3951

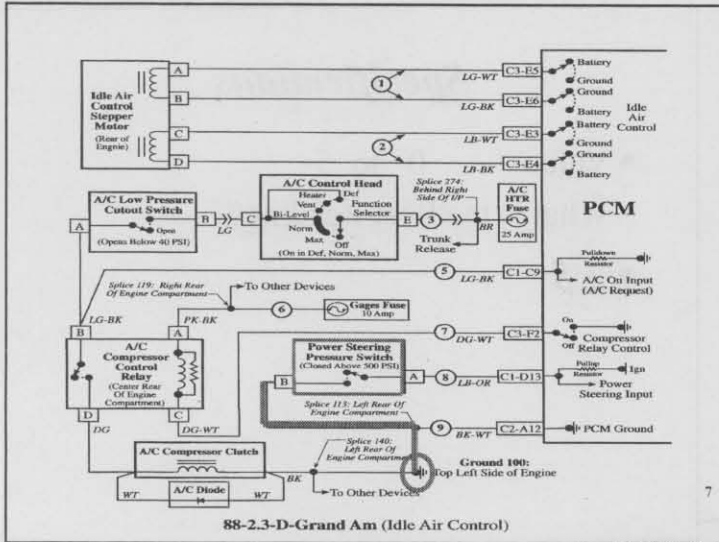

Know your circuit! By using vehicle specific information, you will know what your tester will display before you connect to the circuit.

In this case, the meter is connected to a power steering pressure switch and the graph displays the signal being pulled to ground.

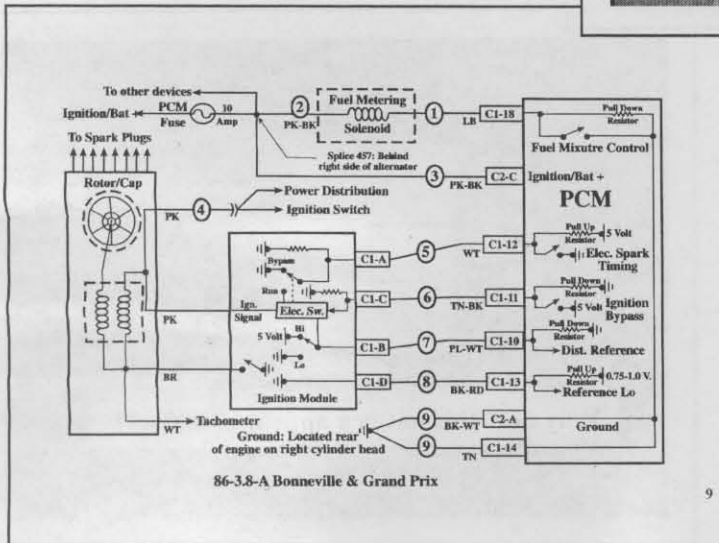
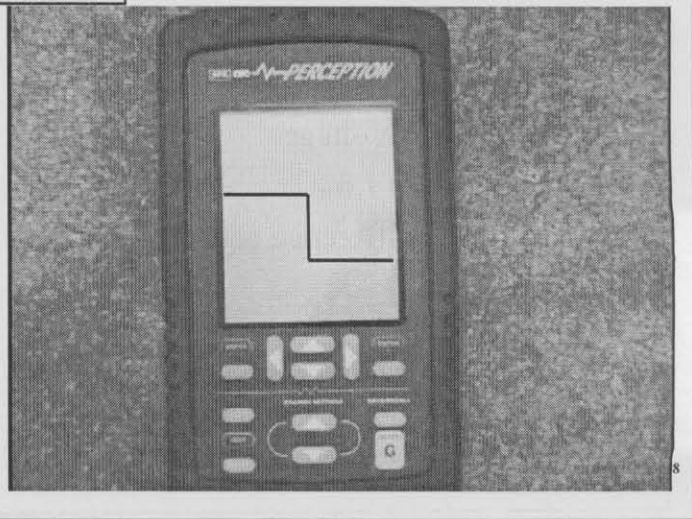

Having vehicle specific wiring schematics, such as these supplied by MPC Publishing, offer diagnostic information not available anywhere else.

**NOTES:**

---



---



---



---

Here is another example of how vehicle specific wiring information is crucial to accurate diagnosis. When attempting to graph the power supplied to the ignition module, the vehicle specific diagram shows us the power supply is shared with the ignition coil.

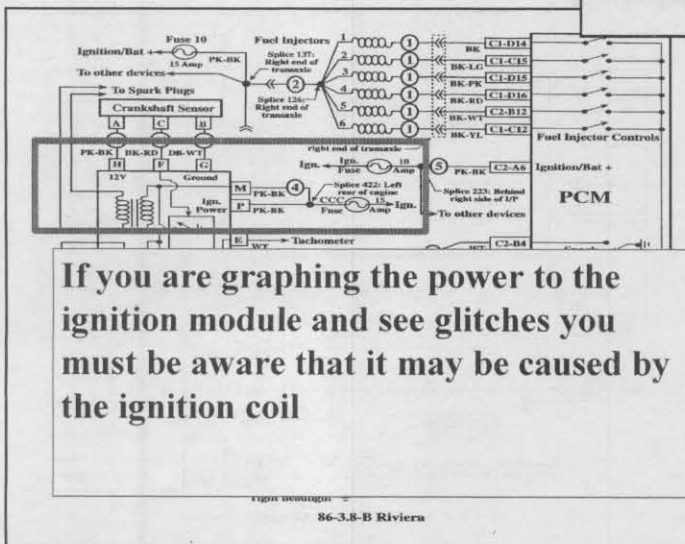
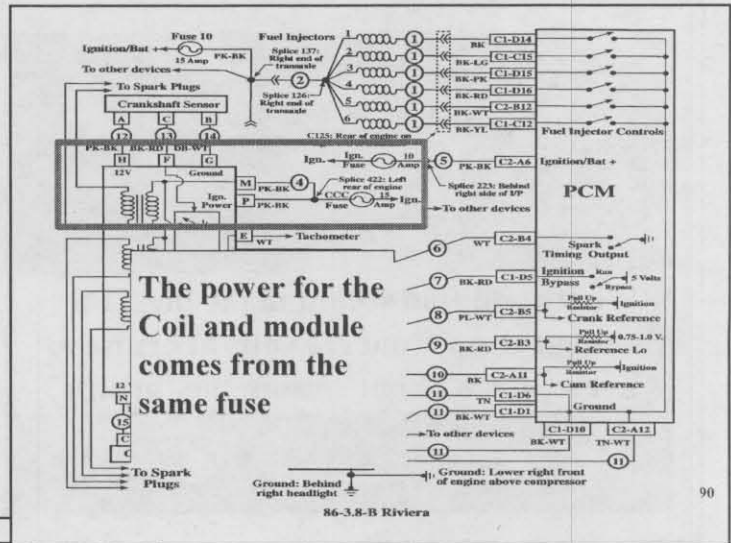

Glitches seen in the module power could be caused by the ignition coil.

But on this vehicle, the power feeds are separated and even supplied by different fuses.

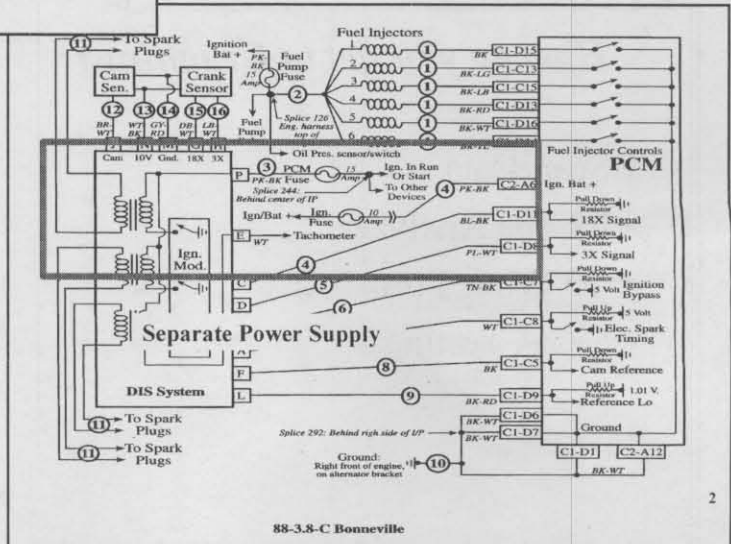

**NOTES:**

- \_\_\_\_\_
- \_\_\_\_\_
- \_\_\_\_\_
- \_\_\_\_\_
- \_\_\_\_\_

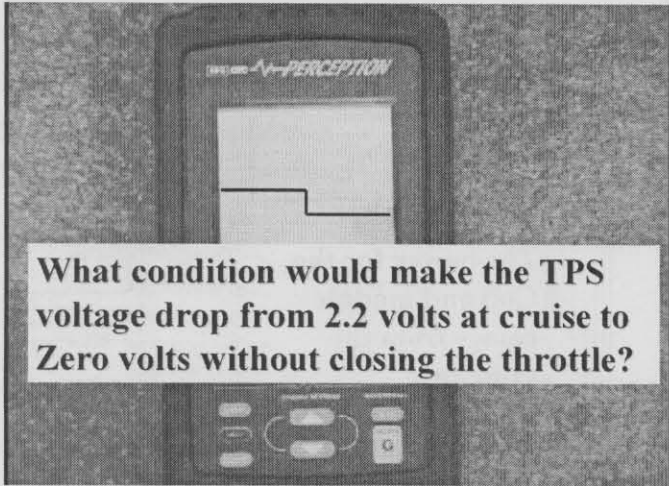

**What condition would make the TPS voltage drop from 2.2 volts at cruise to Zero volts without closing the throttle?**

What could cause the TPS voltage to drop from 2.2 volts at cruise, to 0 volts without closing the throttle.

By reviewing the vehicle specific wiring diagram, we see the TPS has a 5 volt pull-up resistor in the PCM on the signal circuit. So an open would cause the TPS to read 5 volts. What would cause it to read 0 volts?

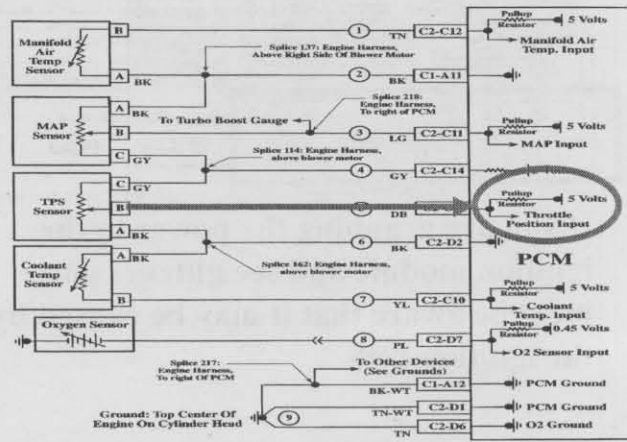

86-1.8-J Sunbird Turbo (Engine Sensors)

### How do you get to Graphing?

- Scan-Data
- Engine Analyzer
- O2 Wave Form
- 5-Gas Testing

How do you get to the point where you will start to graph some sort of data?

### NOTES:

---



---



---



---

Here is a TPS and an oxygen sensor displayed on a graph. The oxygen sensor shows the system is in fuel control.

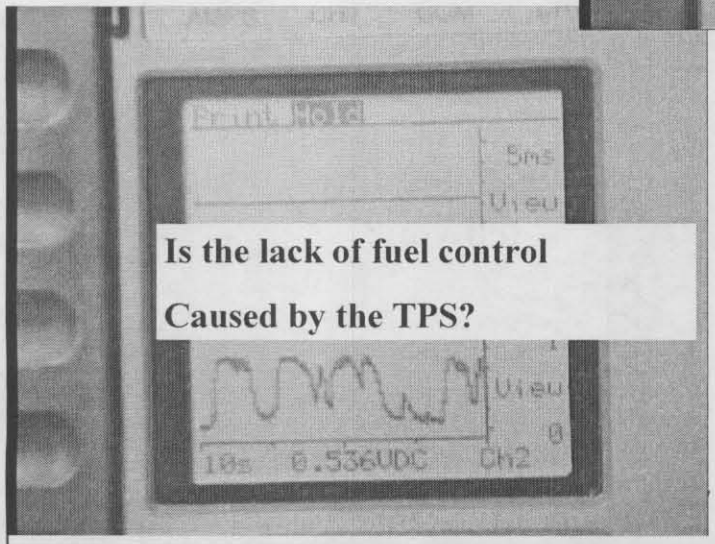
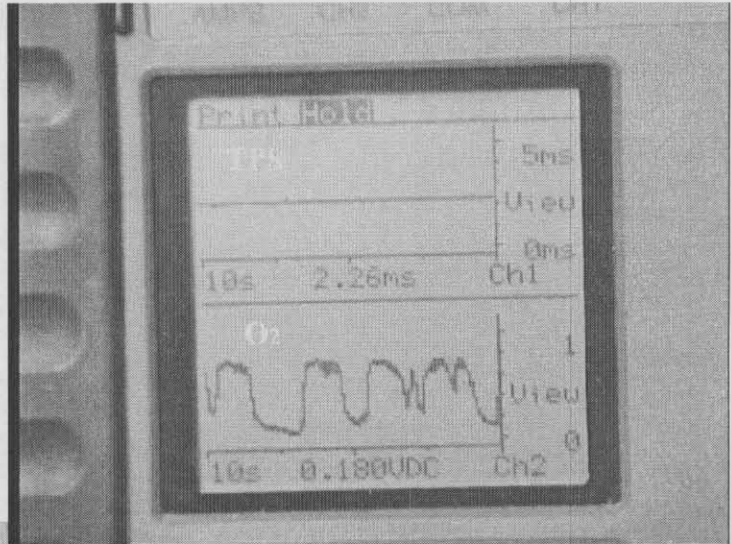

**Is the lack of fuel control  
Caused by the TPS?**

Here the oxygen sensor momentarily goes lean.

Is the TPS causing the loss of fuel control?

Open the throttle and see if the TPS is working. Then watch for a response from the oxygen sensor.

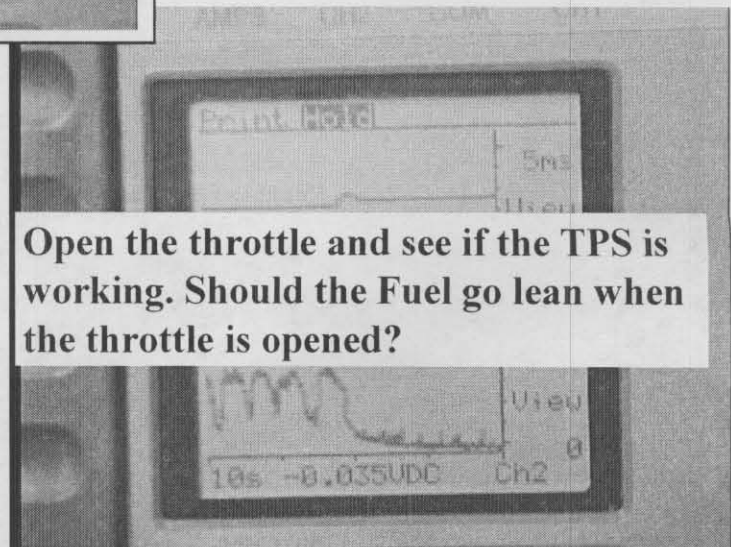

**Open the throttle and see if the TPS is working. Should the Fuel go lean when the throttle is opened?**

**NOTES:**

---



---



---



---

**This is what a fuel injector should look like when graphed.**

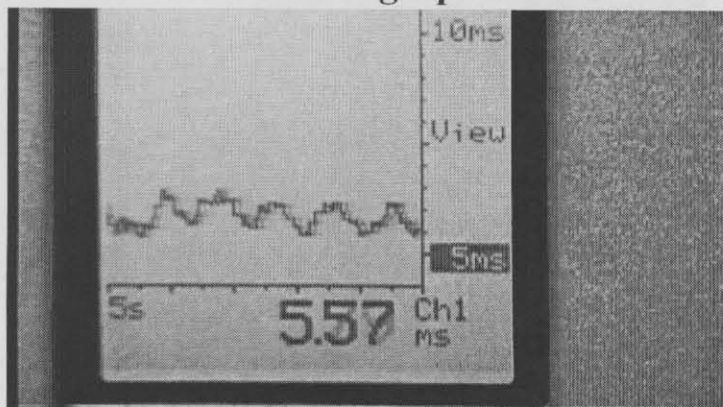

This is the correct representation of fuel injector pulse width on a graphing multi meter. Notice the shape resembles that of an oxygen sensor waveform in proper fuel control. The rising and falling action of the graph relates to increasing and decreasing injector pulse width, in response to the oxygen sensor.

This graph leads the technician toward testing fuel control. Because the changes in the graph are sharp and quick, we know the system is not in proper fuel control. Could the PCM be the problem?

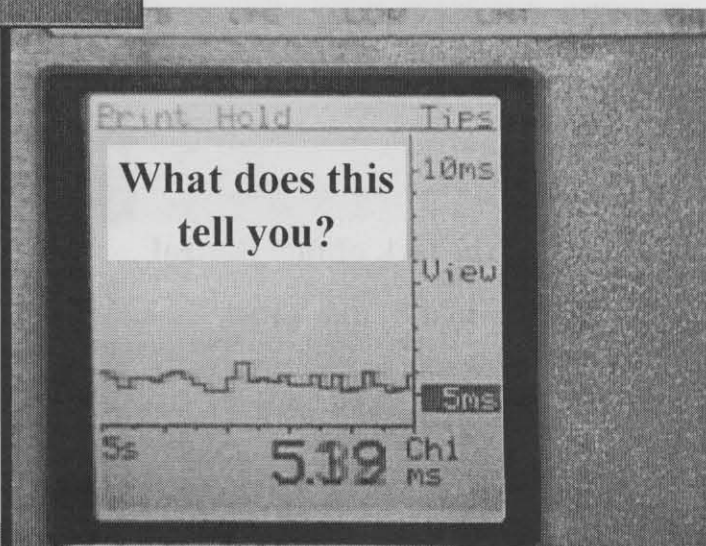

**What does this tell you?**

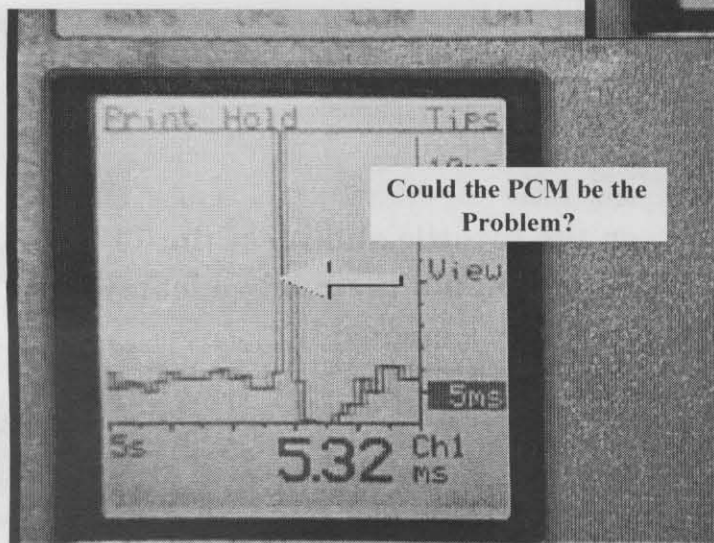

**Could the PCM be the Problem?**

Perform a snap-throttle test and watch the PCM's response in pulse width. Here the PCM reacted to the quick change in TPS with a fast fuel response. After the additional fuel was added, the PCM responded by subtracting fuel. In this case, the PCM seems to be working OK.

**NOTES:**

---

---

---

---

---

What scan-data would you use to verify that this condition actually exists? The first would be oxygen sensor. Next would be LTFT or long term fuel trim. Study the scan-data to determine if the PCM was responding to a fuel control input.

**What scan-tool Data would be a verification for this condition?**

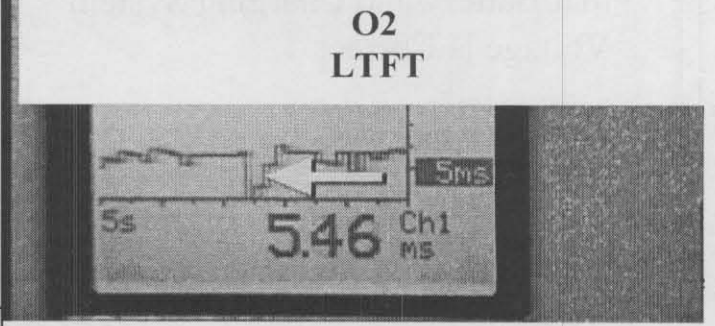

***If LTFT is High And O2 is Low***

The problem is with the Fuel Delivery System

When studying long term fuel trim, if LTFT is high and oxygen sensor is low, then there is a fuel delivery problem. The oxygen sensor is reporting a lean condition that cannot be compensated for by normal fuel control. If long term fuel trim is high and

103

oxygen sensor is also high, then this would lead us to a computer system problem. The PCM is adding fuel even though the oxygen sensor is reporting a rich condition.

***If LTFT is High And O2 is High***

The problem is with the Computer System

104

**NOTES:**

---



---



---



---



---



## Looking at Inputs

- A good place to begin is to check that Battery and Charging System Voltage is Correct

When studying scan-data and looking at the inputs, a good place to begin is by checking the battery or charging system voltage.

105

A sensor simulator is a dynamic tester that sends a substitute signal to the PCM, in effect replacing a questionable component on the vehicle. As the signal from the sensor simulator changes, the PCM should react.

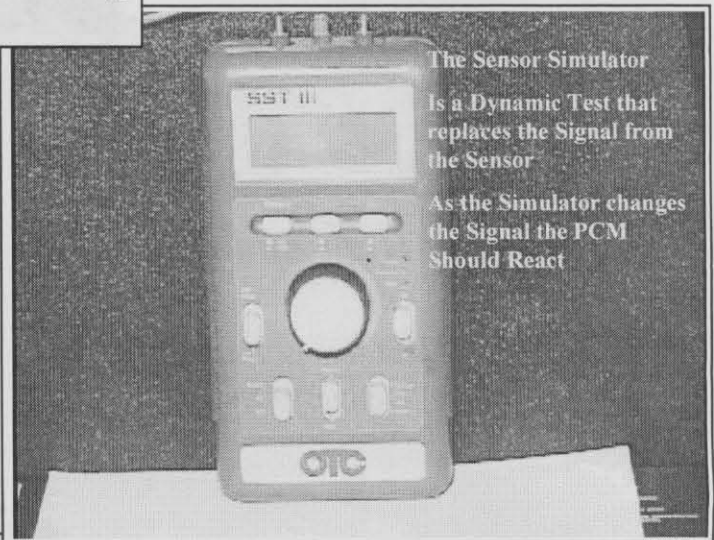

## Sweep Testing The Computer

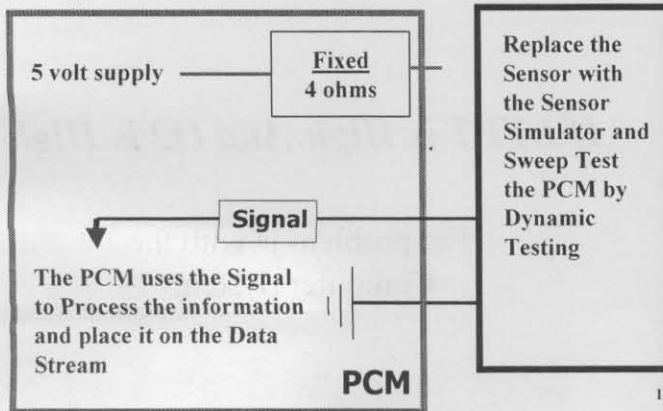

Replace the sensor with the sensor simulator and dial in a known good value, based on vehicle specific information, and watch the scan-tool for the correct reaction.

## NOTES:

---

---

---

---

---

There are many sensor simulators on the market, here are some of the features and controls that are available.



Connect the Pos. Lead to Signal and Neg. Lead to Ground  
Dial the Correct Signal (This GM Voltage)  
Then Disconnect the Sensor

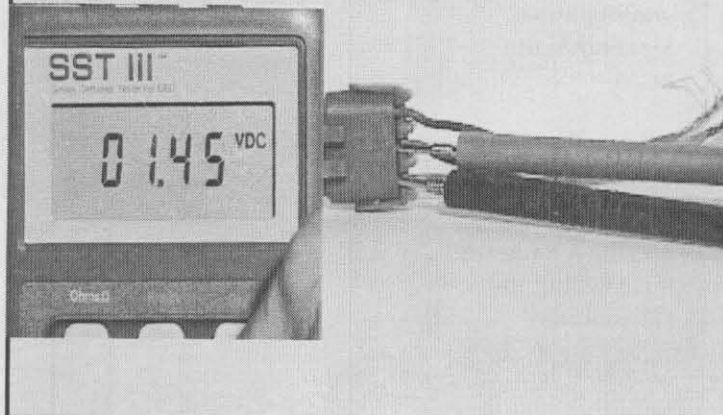

Here is one use for a sensor simulator. We are going to connect the red lead to the signal wire, to the sensor and the black lead to the sensor ground. Then dial in the desired voltage.

Here is how this connection would look on the TPS connector.

Connect the Pos. Lead to Signal and Neg. Lead to Ground  
Dial the Correct Signal (This GM Voltage)  
Then Disconnect the Sensor

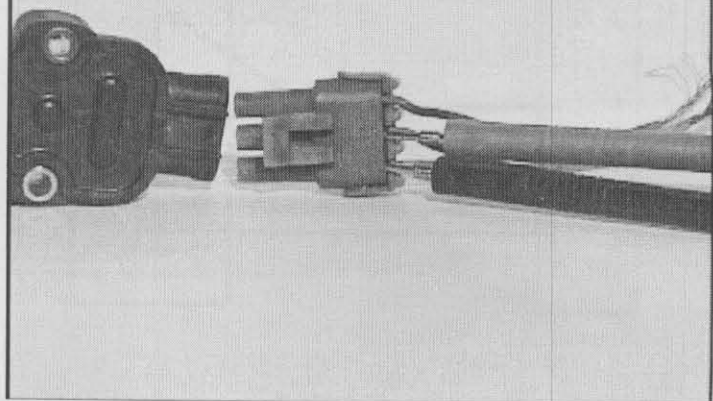

**NOTES:**

---



---



---



---



---

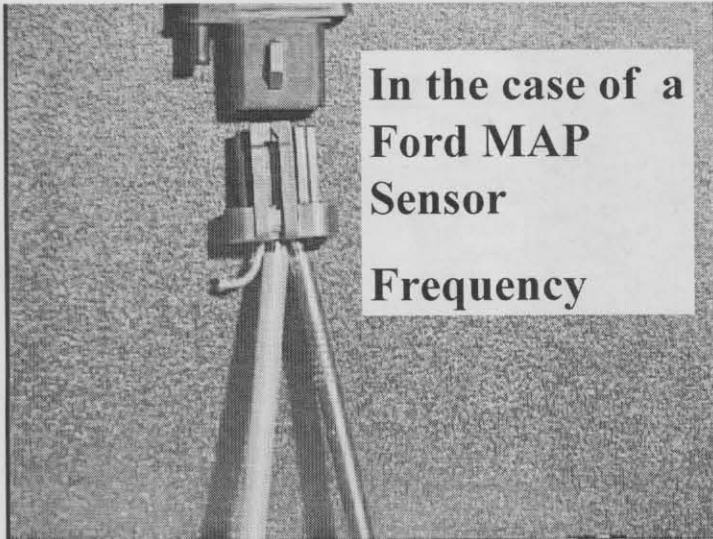

**In the case of a Ford MAP Sensor Frequency**

Sensor simulators can also supply variable frequency. In this case, we can supply a changing frequency to simulate a Ford MAP sensor.

Some sensor simulators can also simulate a switching oxygen sensor. By driving the system rich and lean with the simulator, we can watch the scan-tool for the correct fuel control response.

**Drive the Engine Rich and Lean By sending an O2 Signal into the PCM**

**The PCM should make Fuel and Timing Changes if it is reading the O2 correctly**

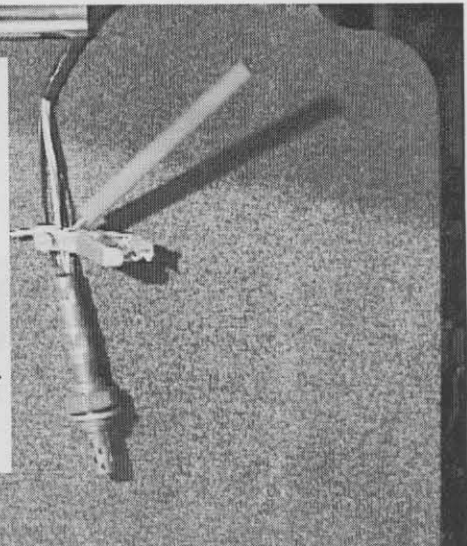

In this example of a three wire

**3-Wire Inputs**

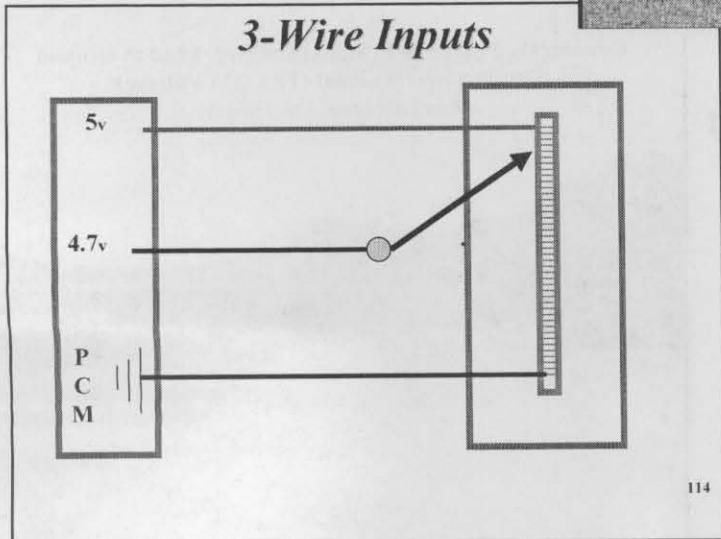

sensor, we can see the sensor has a 5 volt reference and a ground. The signal voltage changes depending on the position of the sweeper arm on the resistor. In the position shown, the 5 volt supply travels through very little resistance so the voltage returned to the PCM is high.

**NOTES:**

---



---



---



---

Here with the sweeper arm in the center position, the reference voltage must pass through additional resistance. The signal voltage returned to the PCM is reduced.

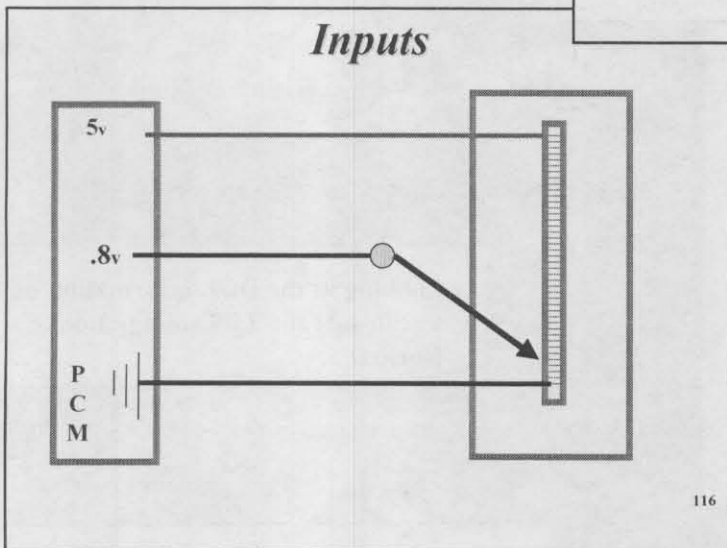
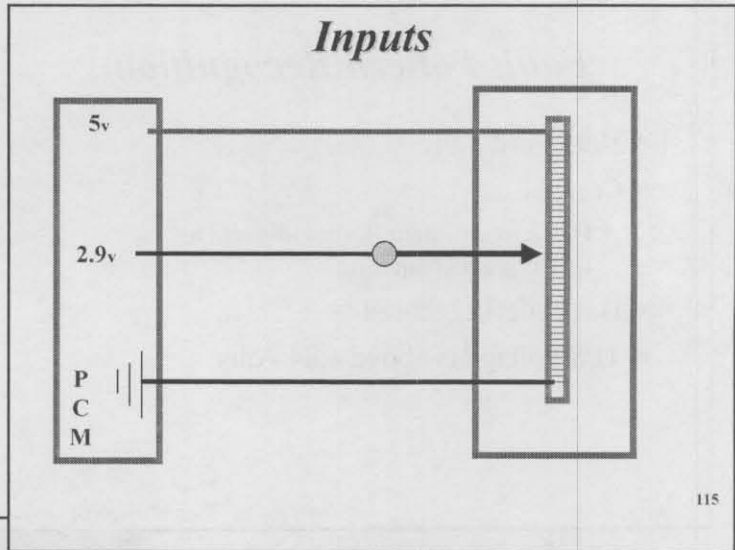

In this example, the sweeper arm is in the lowest position. Reference voltage must pass through the maximum amount of resistance. The signal voltage returned to the PCM is low.

In the case of a MAP sensor, a diaphragm flexes causing the signal voltage to the PCM to change.

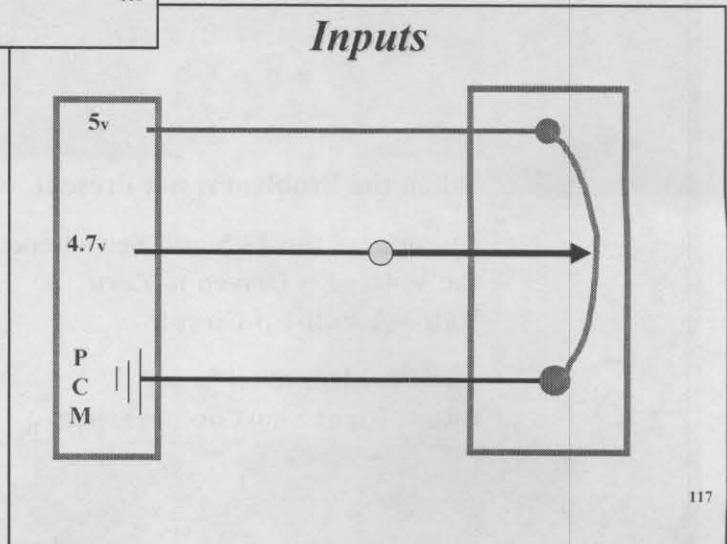

**NOTES:**

---



---



---



---



---

## Fault Pattern Recognition

- 1995 Ford 5.0L
- Complaint:
  - Has a Intermittent Rough Idle and an Intermittent Hesitation
- Has code 122 stored
- TPS voltage is above 4.84 volts

This 1995 Ford has a customer complaint of a rough idle and an intermittent hesitation. A quick check with a scan-tool reveals a code 122, TPS voltage above 4.84 volts.

Looking at the scan-data, the TPS voltage appears to be normal with a reading of 0.86 volts.

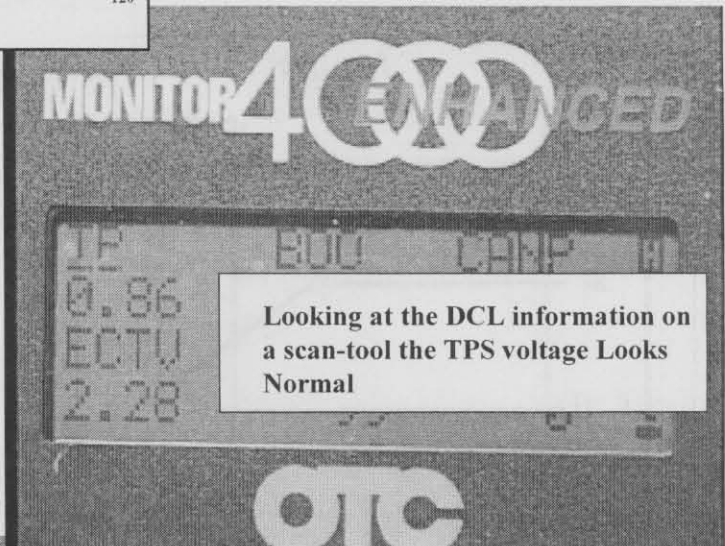

When the problem is not present

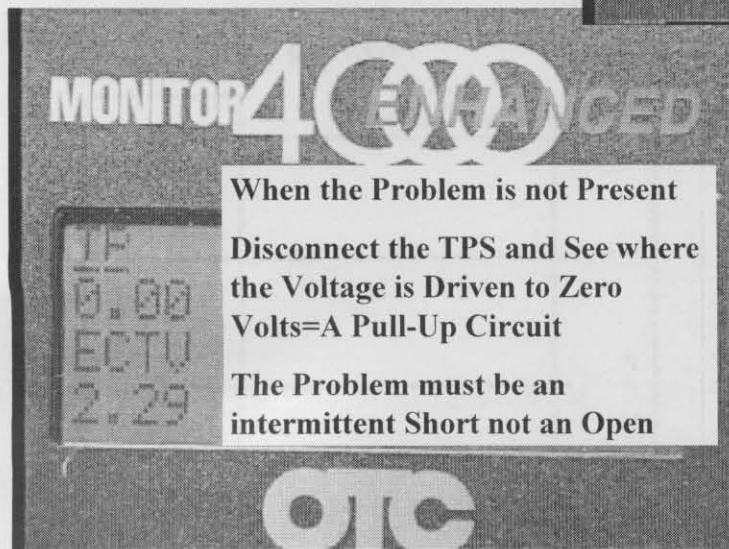

and the TPS value on the scan-tool in normal, disconnect the TPS and read the scan-tool. In this case, the TPS voltage went to 0 volts when disconnected. There is no pull-up resistor in the PCM for this circuit. The problem must be an intermittent short to power not an open.

### NOTES:

---



---



---



---

Performing the Ford wiggle test through the scan-tool, we quickly found a short in the connector to the TPS.

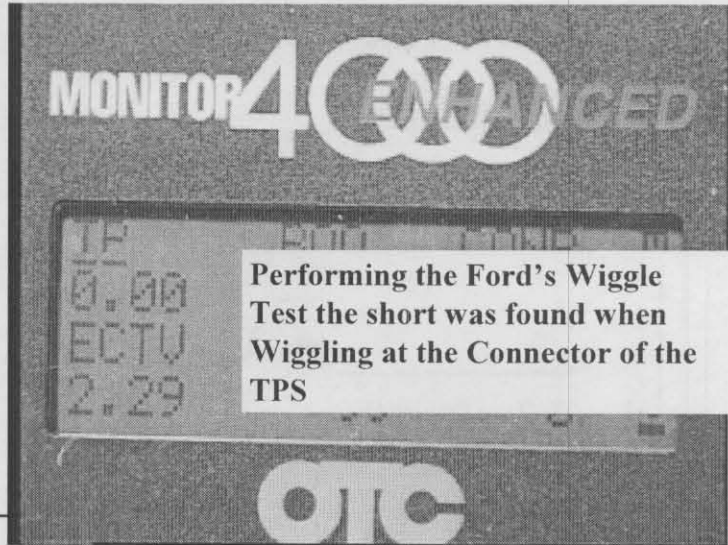

### *Throttle Position Sensors*

- The TPS is used by the Computer to determine if the throttle:
- Key-On-Engine-Off
- Open or Closed (Fuel Loader)
- Engine Running
- Is steady or moving
- Is opening (Quickly or Slowly)
- Is it Closing (Quickly or Slowly)
- Accelerator Pump action [ 500% ] or Fuel Cut Off [ 17% ]

127

The TPS is used by the PCM key-on/engine-off to determine if the throttle is open or closed. While the engine is running, the TPS reports if the throttle is moving and how fast. The TPS also acts as an electronic accelerator pump.

Closed throttle TPS voltage is vehicle specific. Generic values should never be used. Incorrect values can cause problems such as uneven idle, hesitation or surging.

### *Testing The TPS*

- Closed Throttle Voltage is Vehicle Specific
- An incorrect values may cause the following problems:
- Hunting for Idle
- Off Idle acceleration Hesitation (Tip In)
- The PCM can not recognize Wide-Open-Throttle
- Surging at cruse speeds

128

### **NOTES:**

---



---



---



---



---

**If TPS Voltage is Incorrect**

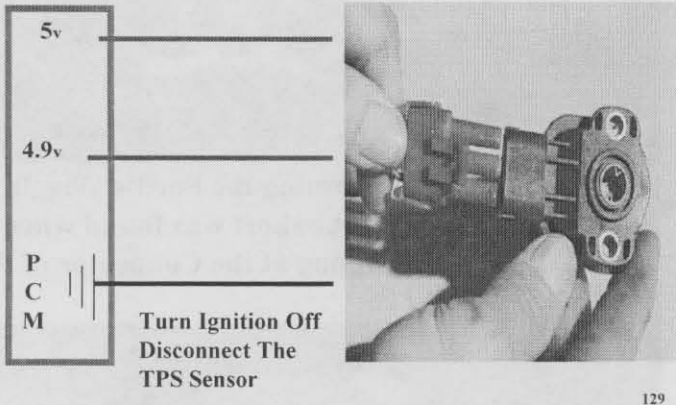

If the throttle position sensor voltage is found to be incorrect, turn the ignition off and disconnect the sensor.

Place a jumper wire between the voltage reference terminal and the signal terminal at the TPS connector. Turn the ignition on. Read the TPS voltage on the scan-tool. The voltage must read 4.9 volts - 5.1 volts.

**Place jumper between V/Ref and Signal**

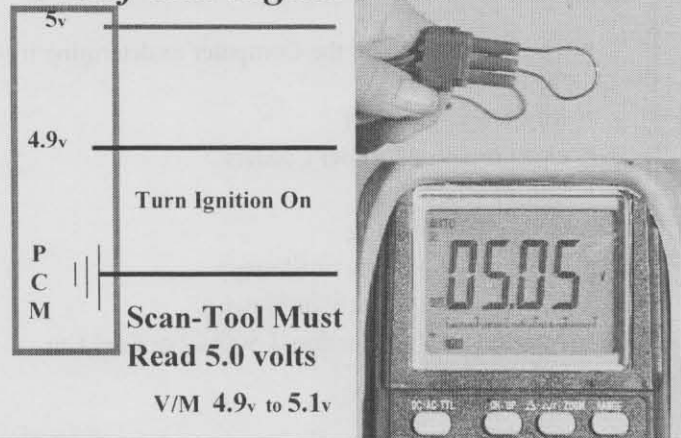

**Cycle ignition Off Then On**

Place jumper between Signal And Ground

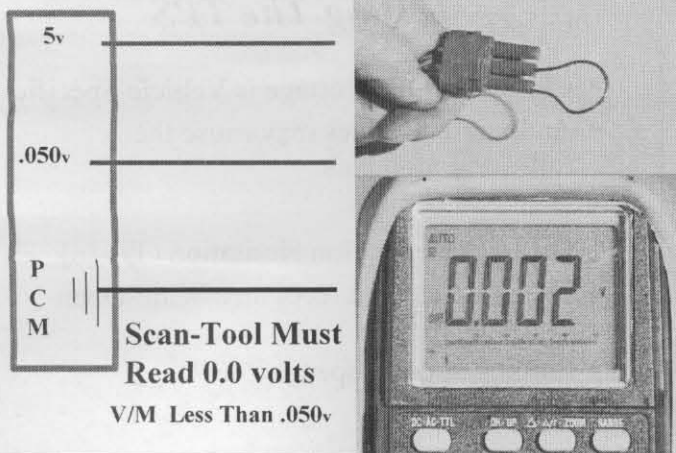

Cycle the ignition off then on. Place the jumper wire across the signal and ground terminals at the TPS connector. On the scan-tool, the TPS voltage must read 0 volts.

**NOTES:**

---



---



---



---



---

There are several reasons why TPS voltage may be incorrect. There could be excessive resistance on the voltage reference wire, signal wire or ground wire. There could also be voltage drops across splices or connectors, which will effect TPS voltage.

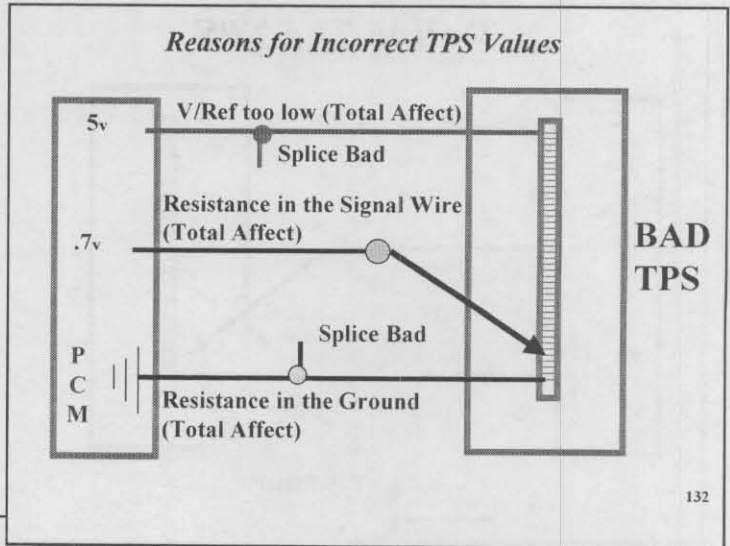

### Testing The TPS

- Wide-Open-Throttle-Voltage 4.6v min. at WOT
- Chrysler 2.7v higher than closed throttle voltage
- An incorrect values may cause the following problems:
  - The PCM can not recognize Wide-Open-Throttle
  - Surging at cruise speeds
  - Fuel Cut Off Problems
  - No Clear Flood operation

133

On many vehicles, the TPS must reach 4.7 volts in order to be considered wide open throttle. On Chrysler vehicles, the TPS must rise 2.7 volts above closed throttle voltage to be considered wide open throttle.

*Asian 3.9*

Actual TPS voltage should be compared to the scan-data to verify the PCM is interpreting the data correctly.

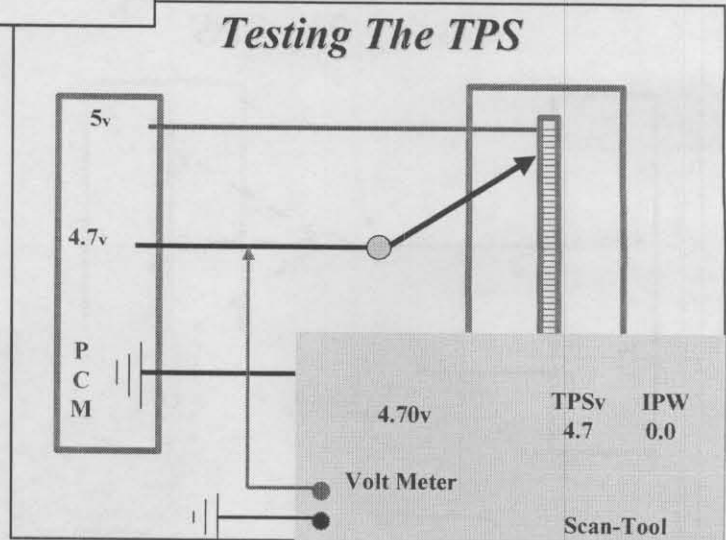

### NOTES:

---



---



---



---



### Testing The TPS

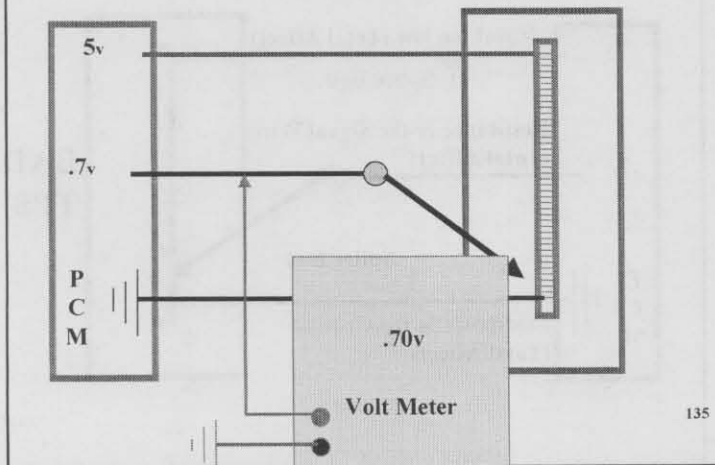

The throttle position sensor can also be sweep tested using a digital multi-meter. Sweep the TPS slowly open and closed, while watching the voltage rise and fall. Be sure to compare closed throttle voltage to the vehicle specific specifications.

135

It is also important to measure wide open throttle voltage when using the digital multi-meter to sweep the throttle position sensor.

### Testing The TPS

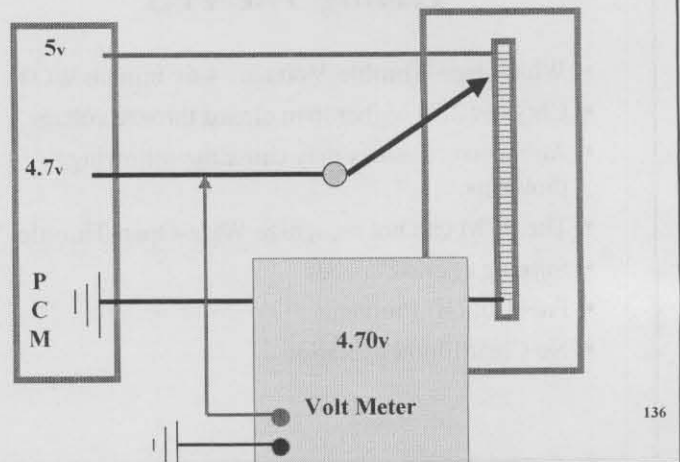

136

### Testing The TPS

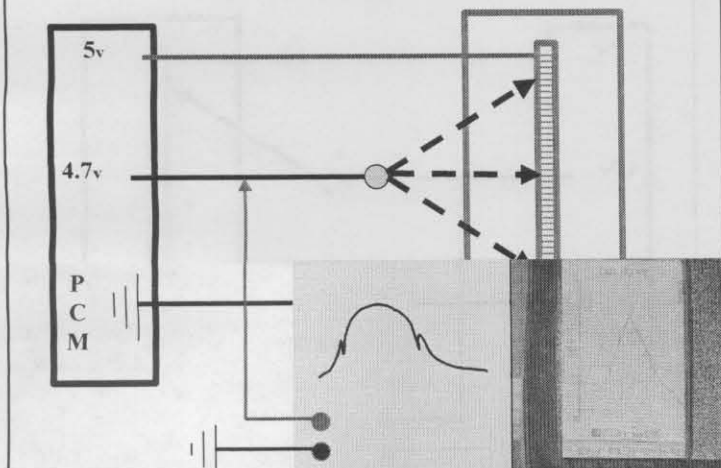

By far, the best way to sweep test a throttle position sensor or any sensor for that matter, is with a digital storage oscilloscope or lab scope. The lab scope allows the technician to watch the entire sweep test on a single screen if a slower time base is selected.

### NOTES:

---

---

---

---

---

---

Faster time base settings allow the technician to see more detail in the waveform. It is recommended that the TPS be swept at fast and slow time base settings to get a good overall picture of throttle position sensor operation.

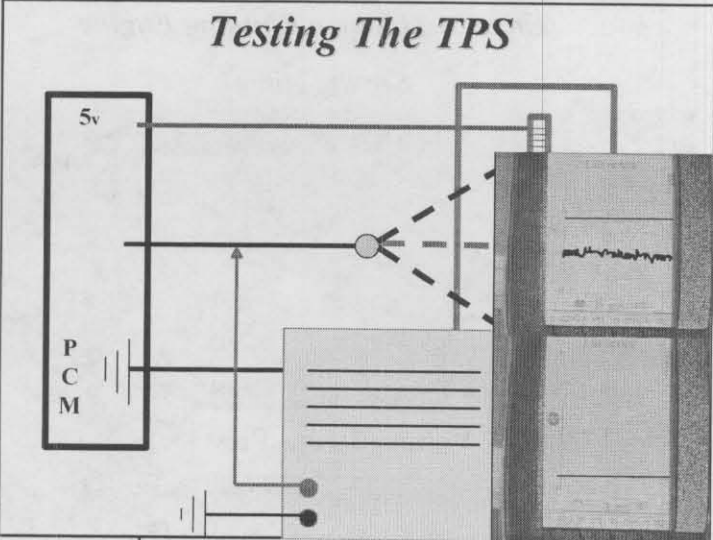

*Open And Close The Throttle Normal*

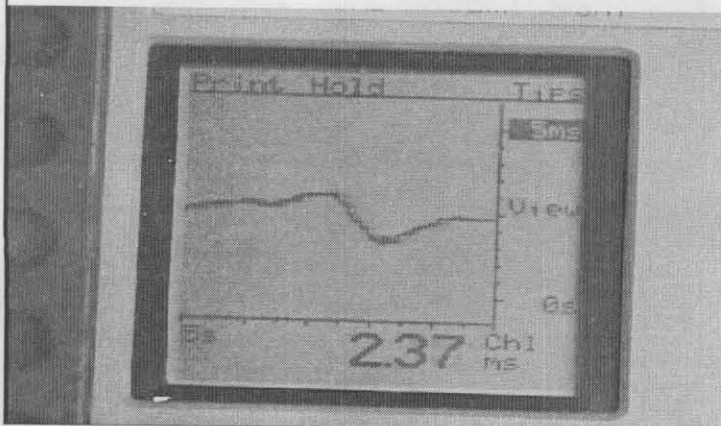

A throttle position sensor can also be sweep tested on a graphing multi-meter. Although this method is not as good as using a lab scope, it is much better than a digital multi-meter or scan-tool.

While sweeping the TPS, watch

the graph for any noise or glitches which can indicate a faulty sensor.

*Snap the Throttle and see the noise appear*

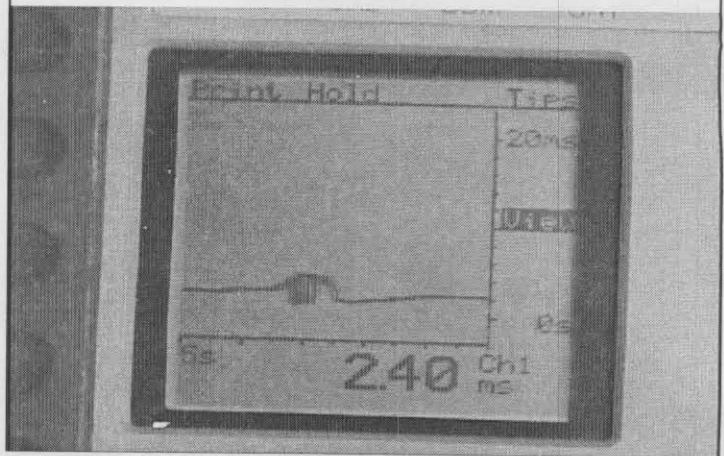

**NOTES:**

---



---



---



---



---

*This is a TPS on a Running Engine*

*See the glitch?*

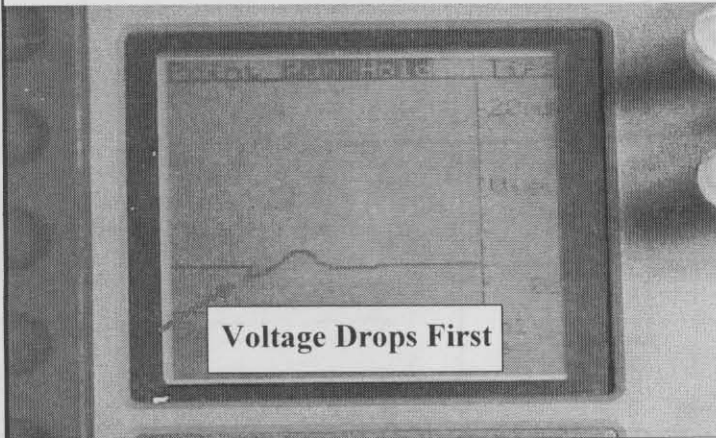

This throttle position sensor has a glitch on acceleration. The voltage drops off before it starts to climb. This will cause a hesitation on acceleration.

Here is a snap throttle test on a graphing meter.

*Here is a TPS when snapped open*

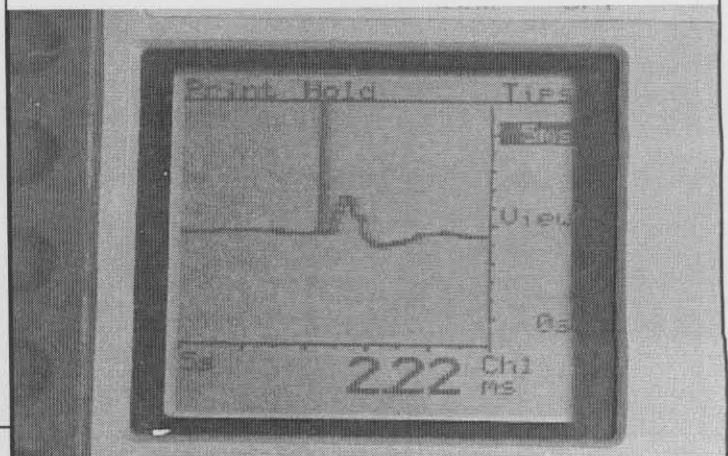

### *Inputs*

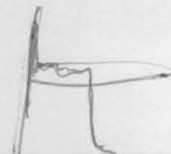
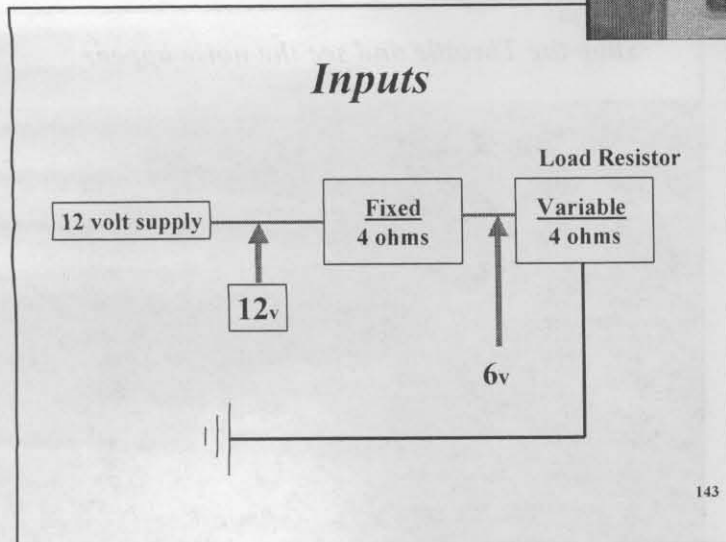

### **NOTES:**

---

---

---

---

---

### Inputs

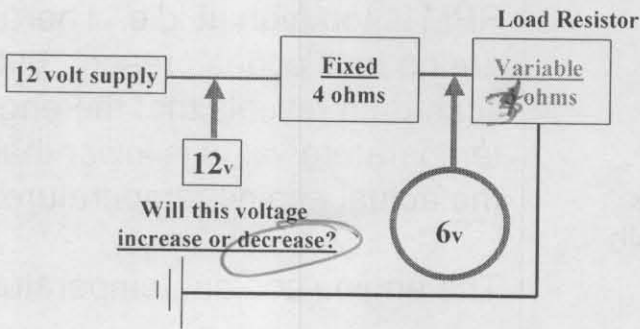

144

### NOTES:

### Inputs

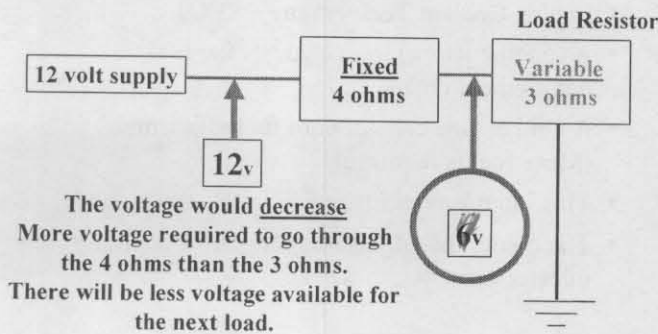

145

### Inputs

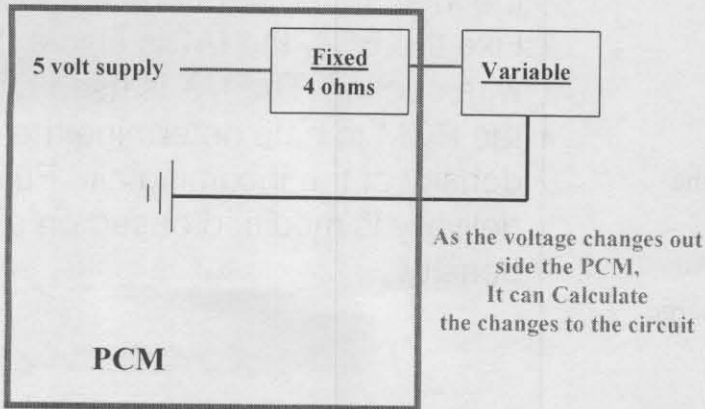

146

### NOTES:

### *Fault Pattern Recognition*

- 1994 3.0L Dodge Mini-Van
- Complaint:
  - Engine RPM too High at Idle - 1150 RPM
- No Codes
- Scan-Data Shows that the ECT indicates engine temperature is lower than it actually is

148

Our next problem vehicle is a 1994 Dodge mini-van. The customer complaint is the engine RPM is too high at idle. There are no fault codes present, but scan-data reveals that the engine temperature value is lower than the actual engine temperature.

The engine coolant temperature

sensor reports the operating temperature of the engine to the PCM. The PCM also uses the coolant temperature sensor on cold start-up as an electronic choke. At lower temperatures, injector pulse width is increased to aid starting. Another temperature sensor is

### *Temperature Sensing*

- Engine Coolant Temperature — ECT
- As engine temperature changes the fuel requirement changes
- A cold engine can not burn fuel efficiently (More fuel is required)
- This input is read in the KEY ON starting mode,
- The colder the engine, the longer the cranking injector pulse width will be

149

### *Temperature Sensing*

- 2-wire Inputs
- Inlet Air Temperature — IAT
- The temperature of the Air changes the density of the Air
- Cool Air is more Dense than warm Air
- IAT is a modifier for the air / fuel charge

150

the inlet air temperature sensor. Like the ECT, the IAT is also a 2-wire sensor. The IAT is used by the PCM to help determine the density of the incoming air. Fuel delivery is modified based on air density.

### **NOTES:**

---

---

---

---

---

The PCM, on Chrysler vehicles, controls the charging system. Chrysler uses a battery temperature sensor to help maintain a proper battery charging rate.

### Temperature Sensing

- Battery Temperature — BAT
- The Chrysler PCM controls the charging voltage
- The PCM needs to know the temperature to control the charging rate

151

### Temperature Sensor Testing

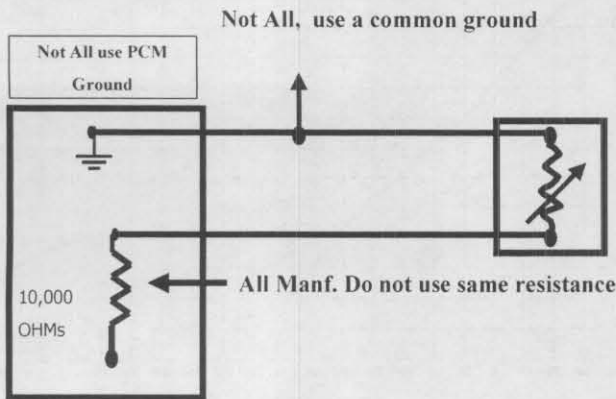

Not all temperature sensors are created equal. Not all sensor circuits use a common ground. Not all temperature sensors use the same resistance curve. Always use vehicle specific information when testing temperature sensors.

152

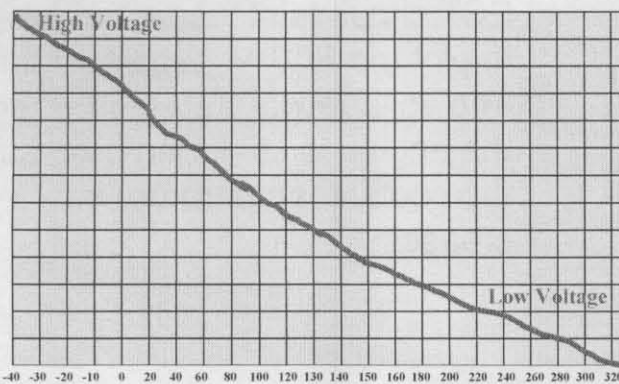

Courtesy of MPC Publishing

Temperature ° F	Resistance	Voltage
+32°	Below Self Test Limit	Below Self Test Limit
+50°	58.8 KΩ	3.50 V
+85°	24.0 KΩ	3.05 V
+100°	16.5 KΩ	2.15 V
+120°	11.0 KΩ	2.20 V
+140°	7.70 KΩ	1.35 V
+160°	5.25 KΩ	0.95 V
+175°	3.85 KΩ	0.78 V
+195°	2.80 KΩ	0.60 V
+212°	2.07 KΩ	0.45 V

NOTES:

---



---



---



---



---

## Temperature Sensor Testing

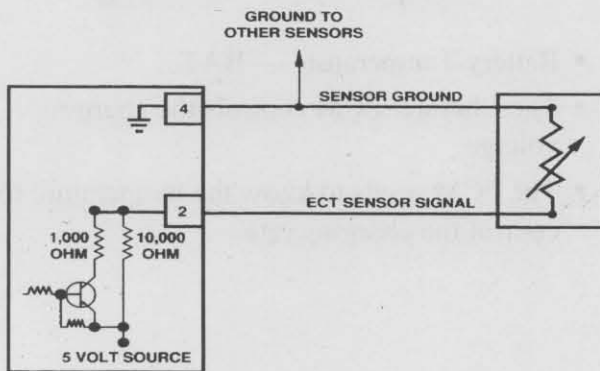

Chrysler and some General Motors vehicles use a dual range engine coolant temperature sensor. These dual range sensor circuits allow the PCM to get a more accurate reading of engine temperature over the entire operating range.

Here is a graph of the dual range engine coolant temperature sensor.

*Coolant Temp Sensors  
can only add fuel  
they cannot take  
fuel away (ever)*

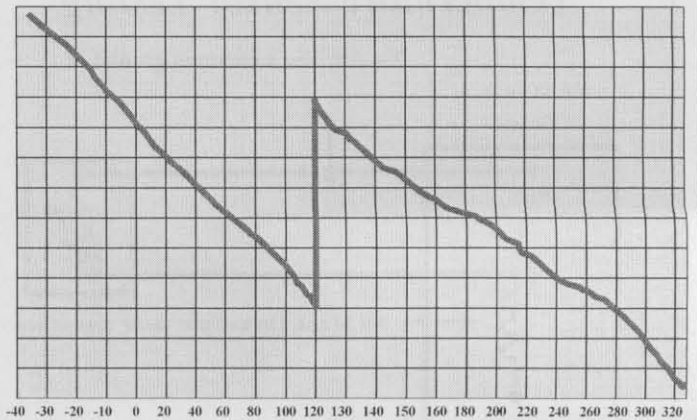

**If you get a diagnostic code referring to the ECT circuit and can not find the reason for the code.**

**Use a DMM or DSO during the cold start of an engine.**

**The DMM voltage should get lower as the engine heats up**

**Then at the dual circuit switch point the voltage should raise and begin to get lower again if the PCM is working correctly**

When attempting to diagnose an ECT circuit fault, use a lab scope to plot the ECT voltage over time. The voltage will start high when the engine is cold, and drop as the coolant temperature increases.

158

### NOTES:

*Shoot with Temp Gun must be within about 4" and at the low side of*

When the engine temperature reaches the switch point, the voltage will rise sharply and then continue to fall again as the engine continues to approach operating temperature.

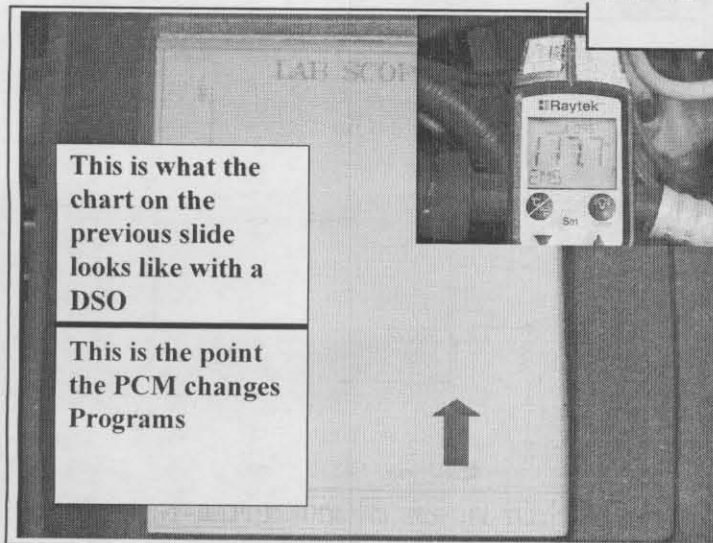
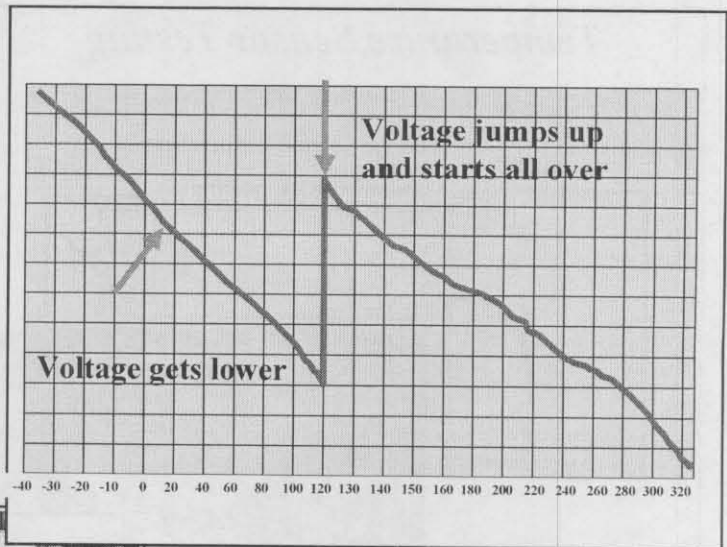

Here is a look at the switch point as seen on a lab scope. This sensor circuit switched at 177.7°f.

As seen in this chart, the voltage should switch at approximately 120°f.

Courtesy of MPC Publishing  
 Dual Range Temperature Chart

Temperature ° F	Resistance	Voltage
-40°	100,700 Ω	4.90 V
+30°	9,600 Ω	3.90 V
+60°	4095 Ω	3.00 V
+80°	2,975 Ω	2.44 V
+100°	1,800 Ω	1.83 V
+120	1350 Ω	4.00V
+140°	835 Ω	3.60 V
+160°	432 Ω	3.20 V
+180°	305 Ω	2.80 V
+210°	185 Ω	2.20 V
+220°	60 Ω	2.00 V

**NOTES:**

Water boils at 212°  
 Steam is Always @ 212°  
 No matter what the water temp is @



## Temperature Sensor Testing

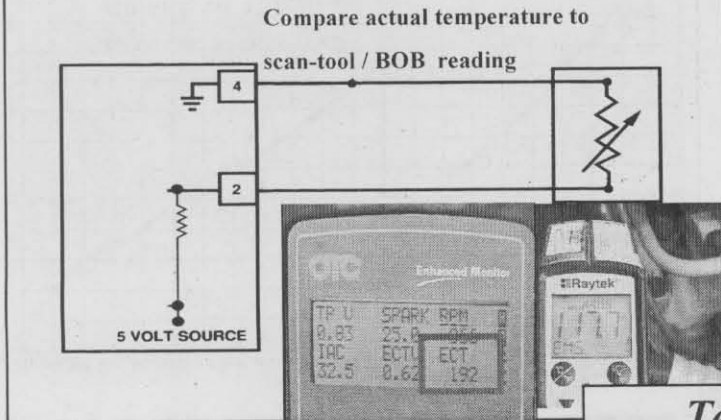

When testing an engine coolant temperature sensor, the actual engine temperature must be compared to scan-data. In this case, the scan-data reads higher than actual engine temperature. Further diagnosis is required.

The next step involves testing the voltage reference to the sensor with a digital multi-meter.

## Temperature Sensor Testing

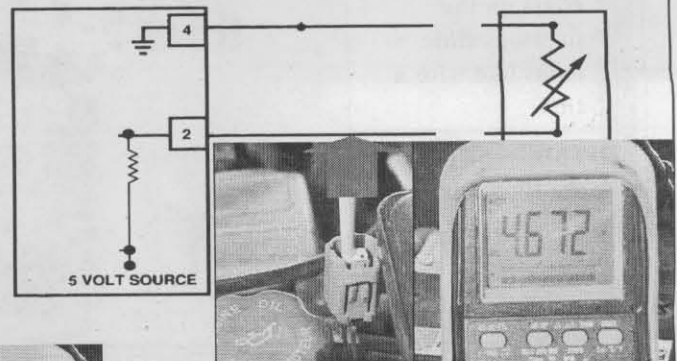

Then test the ground to the sensor. A good ground must read below .050 volts key-on/engine-off.

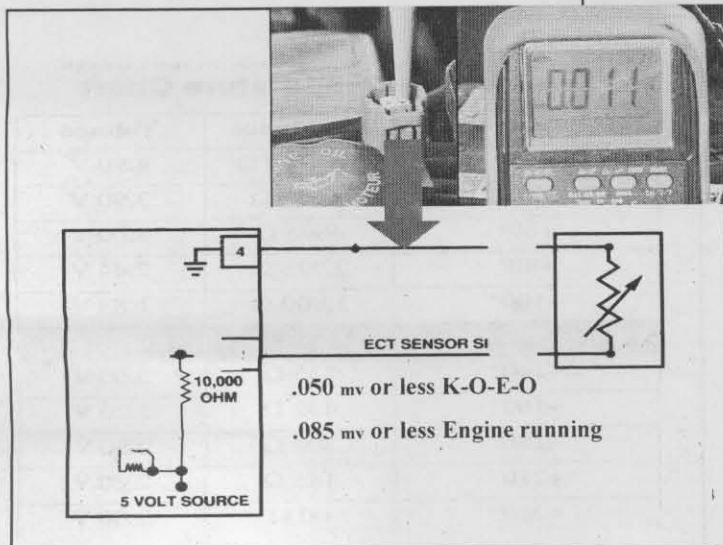

### NOTES:

Negative  
Temperature  
Coefficient  
Sensors

means  
as Temp increases  
Resistance Decreases

Next we must test the PCM's ability to read coolant temperature correctly. Start by disconnecting the ECT. The scan-tool must display -40°f when the ECT circuit is open. Also check for fault codes during this test.

*Same*

### Temperature Sensor Testing

To test the PCM's ability to read a circuit.

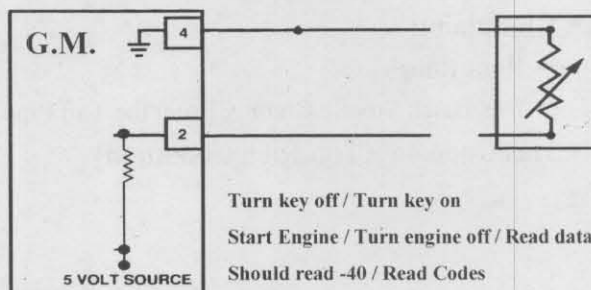

### Temperature Sensor Testing

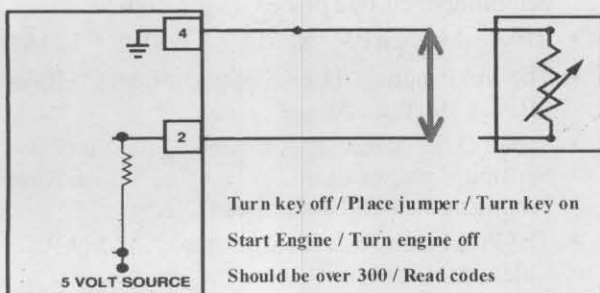

Next short the two terminals at the ECT connector together using a jumper wire. The scan-data must display over 300°f for a shorted ECT circuit. Again, check for fault codes during this test.

*Some pos Gm's may Read 255 Never over (even)*

Using what we have learned during the beginning of this class, how would we perform this test on a Ford or a Chrysler?

### Temperature Sensor Testing

- Using the information from The beginning of this course, how would you do this test on a:
  - FORD?
    - HINT — Voltage
  - CHRYSLER?
    - HINT — DEFAULT

*104 Chrysler  
114 Gm*

167

### NOTES:

---



---



---



---

### *Fault Pattern Recognition*

- 1986 GM 2.5L
- Complaint:
  - Runs Rough
  - Has Black Smoke Coming From the Tail Pipe
- Has Code 45 (Too Rich Condition)

A 1986 General Motors vehicle with a 2.5 litre engine has a complaint of rough running. There is also black smoke coming from the tail pipe. A check with a scan-tool reveals a code 45.

The manifold absolute pressure

169

sensor measures pressure in the intake manifold to determine engine load. The MAP sensor tells the computer how much fuel to add. Speed density systems use MAP and engine speed to calculate air flow.

### *Manifold Absolute Pressure Sensor*

- Measures the Pressure of the Intake Manifold to determine the Load placed on the Engine.
- $RPM \div MAX\ RPM \times MAP \div BARO = \text{LOAD}$
- The MAP signal "TELLS" the computer "HOW MUCH" fuel to add.
- Speed Density measures Incoming Air Flow By Sensing Changes In Intake Pressure Which Result From Engine Load And Speed Changes
- The PCM Combines Temperature And MAP To Calculate Air Flow

170

### *Manifold Absolute Pressure Sensor*

- There are Two Map Engine Management Strategies
- Speed-Density Systems
- The Computer measures the Engine RPM and Manifold Pressure, ECT, IAT, And TPS are important Inputs Also
- RPM the Most Important Sensor

171

There are two MAP sensor based engine management systems. The first is speed density. Speed density systems rely on RPM input first and foremost then MAP sensor. All other inputs are used to modify the fuel delivery.

### **NOTES:**

---

---

---

---

---

Next are the density speed systems used on early Jeep systems. In these systems, MAP is the most important input.

### Manifold Absolute Pressure Sensor

- Density-Speed Systems ( Early Jeep )
- Almost exactly like the Speed-Density Systems
- Except that the MAP is the Most Important Sensor

172

### Barometric Pressure

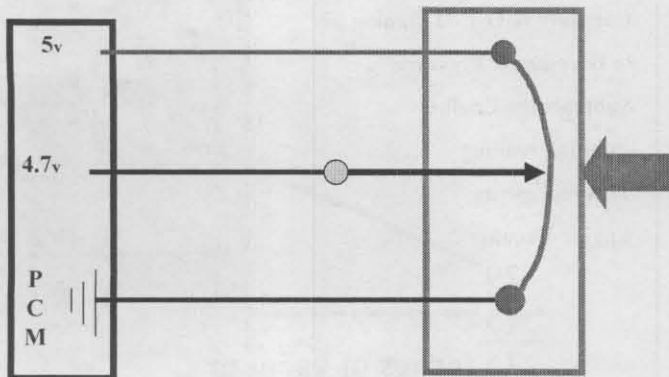

During key-on/engine-off, the MAP sensor is used by the PCM to measure barometric pressure. This gives the PCM a starting point for fuel delivery.

173

At idle, engine vacuum pulls on the MAP sensor diaphragm, causing the signal voltage returned to the PCM to be lower than that during key-on/engine-off. The PCM will interpret voltages between idle and key-on/engine-off as varying loads.

### Engine at Idle

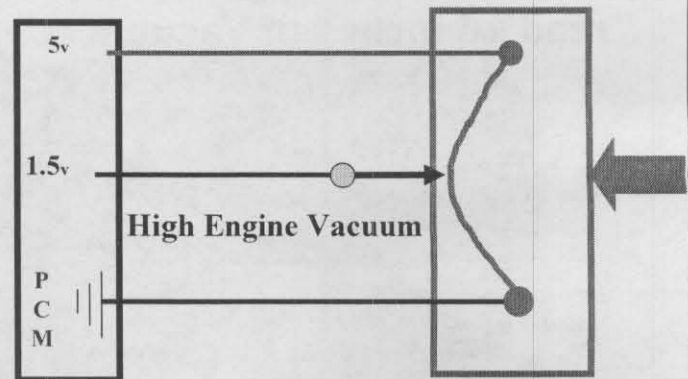

174

NOTES:

*Baro - Map = Vacuum*

**MAP must read Barometric Pressure**

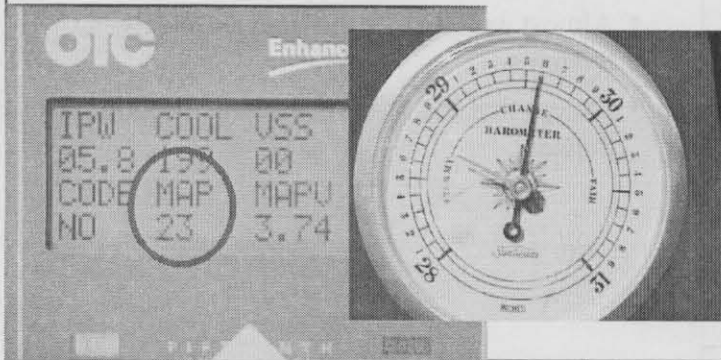

Key-on/engine-off, the MAP sensor must read barometric pressure.

To determine engine vacuum, subtract the engine running MAP reading from the baro reading. This should equal engine vacuum.

**Testing the MAP Sensor**

Compare K-O-E-O reading to Barometric Pressure  
 Subtract the Engine running reading  
 This represents  
 Engine Vacuum

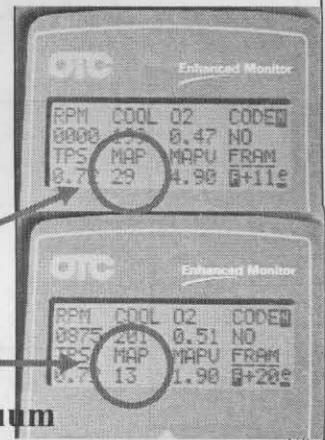

29  
 - 13  
 ---  
 16 inches of vacuum

**The Vacuum Gauge should read 16 inches of Vacuum**

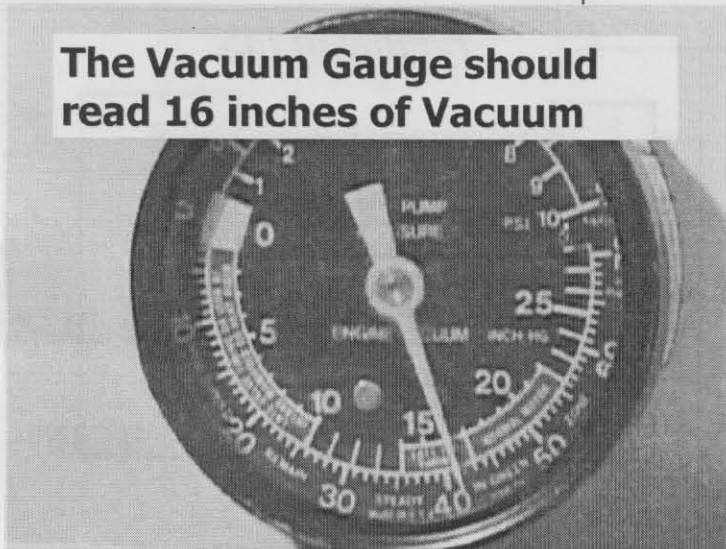

Compare this value to actual engine vacuum measured with a vacuum gauge. If the MAP sensor reading is different than actual engine vacuum, the MAP sensor is lying.

**NOTES:**

Take the Barometer reading from the Barometer and Subtract 1 from every 1000 ft of altitude  
 1" Square 1000 ft high of Air weighs 14.7 #

The best test of the MAP sensor is the sweep test with a lab scope. Watch for noise or glitches in the waveform and compare the voltage reading at different vacuum levels to specifications.

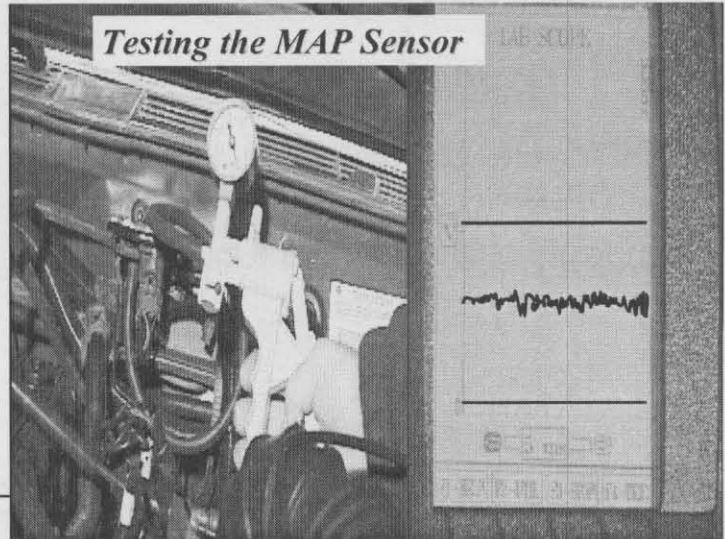

**FORD MAP SENSOR**

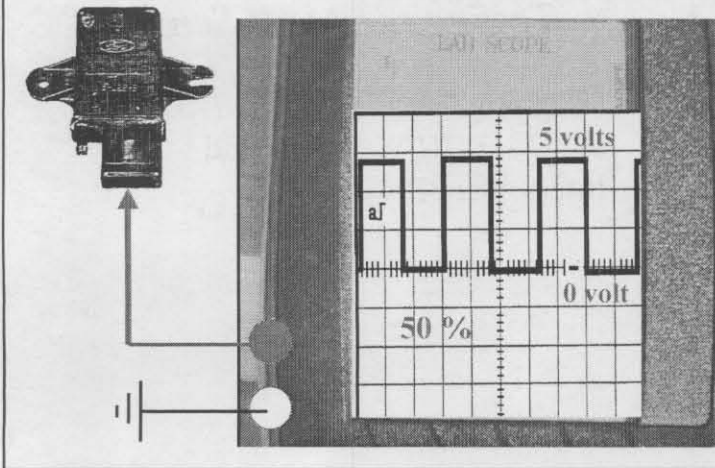

When sweep testing a Ford MAP sensor, the waveform on the lab scope will be a 5 volt square wave with a 50% duty cycle. Apply vacuum in 2" hg increments and compare the frequency to the specification in the charts below. *50% is Important*

Vacuum In Inches Hg.	Frequency	0 to 1,000'	29-30"	159-163 Hz
0"	159 Hz	1,000-2,000'	28-29"	153-157 Hz
2"	153 Hz	2,000-3,000'	27-28"	150-153 Hz
4"	147 Hz	3,000-4,000'	26-27"	147-153 Hz
6"	141 Hz	4,000-5,000'	25-26"	144-150 Hz
8"	135 Hz	5,000-6,000'	24-25"	141-147 Hz
10"	130 Hz	6,000-7,000'	23-24"	139-145 Hz
12"	125 Hz	7,000-8,000'	22-23"	136-143 Hz
14"	120 Hz	8,000-9,000'	21-22"	133-140 Hz
16"	114 Hz	9,000-10,000'	20-21"	130-137 Hz
18"	109 Hz			

**NOTES:**

*full enrich point for Ford*

### *Testing the MAP Sensor*

- Test the MAP like we did the TPS by DRIVING the Voltage High then Low
- Will Test the Wiring and the Computer

Test the MAP sensor in the same manner as we tested the TPS, by driving the signal voltage high and low using a jumper wire. This will test the PCM and wiring circuit.

185

Graphing the MAP sensor output on a graphing multi-meter or the graphing scan-tool can help find intermittent problems.

### *Testing the MAP Sensor*

- Graphing the MAP's *VOLTAGE* or *SCAN-DATA* Will help find Intermittent Problems

186

### *This is a MAP Signal On an Idling Engine*

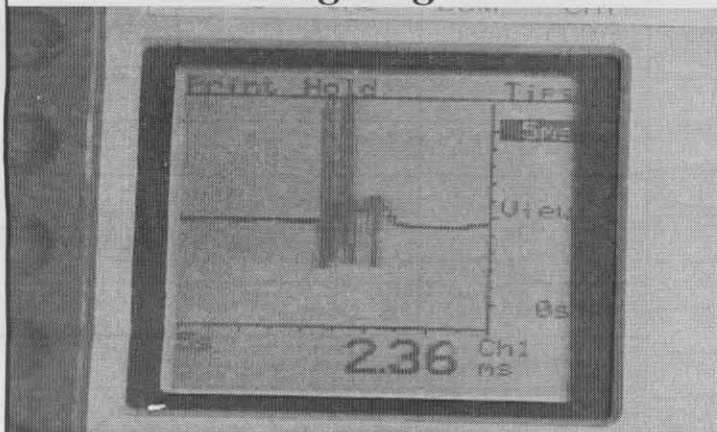

Here is a graph displaying a glitch captured at idle.

#### **NOTES:**

---

---

---

---

---

## Map Glitch 2

Another glitch in the output of a MAP sensor.

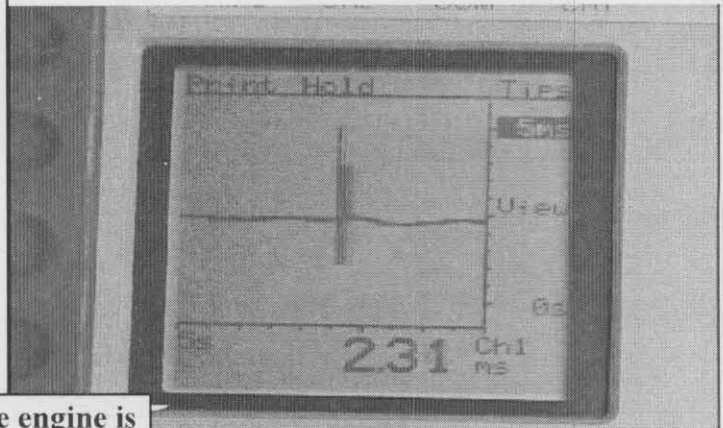

Look at the noise on this MAP when the engine is Accelerated

You Could not see it unless RPM Changed

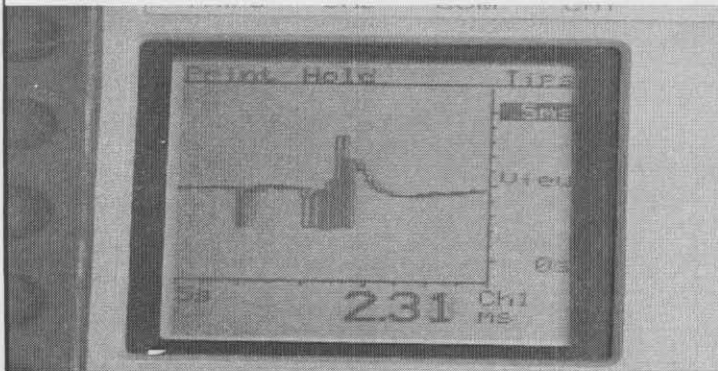

It is important to vary RPM or vacuum applied to the MAP sensor, while graphing. Some failures will not be apparent otherwise.

Our next diagnostic problem is a 1992 Chevrolet van. RPM is fluctuating at idle. Scan-data shows the MAP and RPM values fluctuating. Is the rolling idle causing the MAP to change or is the MAP causing the engine to surge?

## Fault Pattern Recognition

- 1992 5.7L Chevy Van.
- Complaint:
  - At Idle the RPM fluctuates 350 RPM
- What do you want to do?
- Scan-Tool Data shows RPM and MAP signals jumping around.
- Is the Engine RPM causing the MAP to jump around? or
- Is the MAP causing the RPM to jump around?

190

## NOTES:

---

---

---

---

---



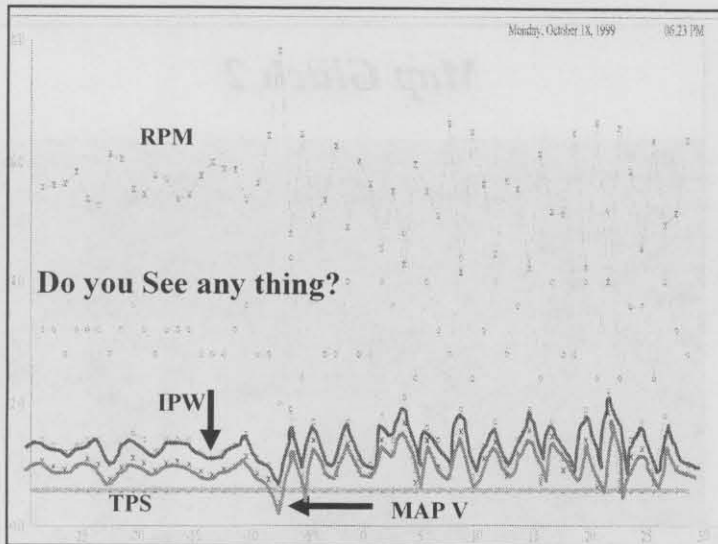

This is a display of scan-data graphed on a PC. The graph shows that the MAP voltage dropped to .3 volts.

It is all too easy to jump to conclusions and condemn the MAP sensor. Use a sensor simulator and determine if a correct MAP sensor value will remedy the problem.

### ***Fault Pattern Recognition***

- It would be easy to say that the MAP Sensor is Bad because of the reading of .3 volts.
- That may be a *good guess* but why guess?
- Don't you want to be sure when replacing parts?

193

### ***Fault Pattern Recognition***

- By using a Sensor Simulator to replace the MAP Signal you can be sure.
- If you put a known good signal into the PCM and the Engine rpm settles down you know it was a Bad MAP Signal causing the problem.

194

If the known good signal from the sensor simulator causes the engine speed to smooth out, you know you have found the cause of the problem, a bad MAP sensor.

### **NOTES:**

---



---



---



---

Here is the result of replacing the defective MAP sensor, a smooth graph.

**Map Signal On Start Up No Problem**

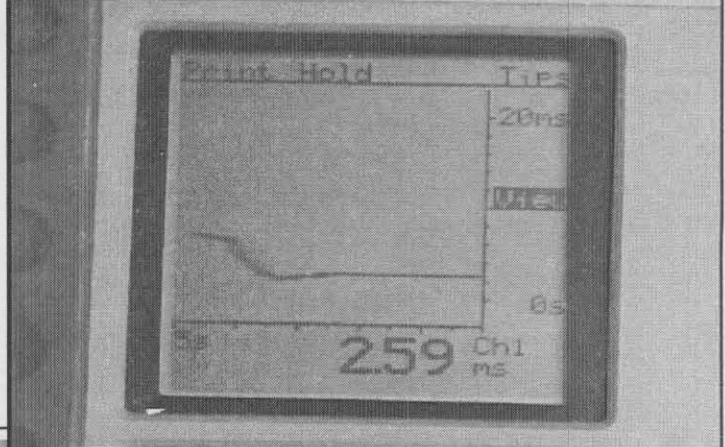

**This is a graph of a ground wire intermittently going open  
On a MAP Sensor**

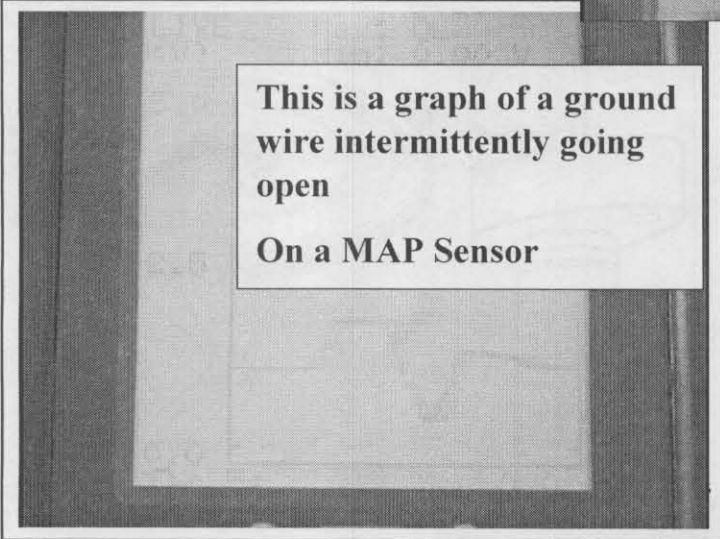

Here is a graph of a MAP problem caused by an intermittent open sensor ground.

Here is another MAP problem which was determined to be caused by a faulty charging system.

**This graph shows a charging system dropping below 8 volts  
intermittently  
The graph is of a MAP Sensor**

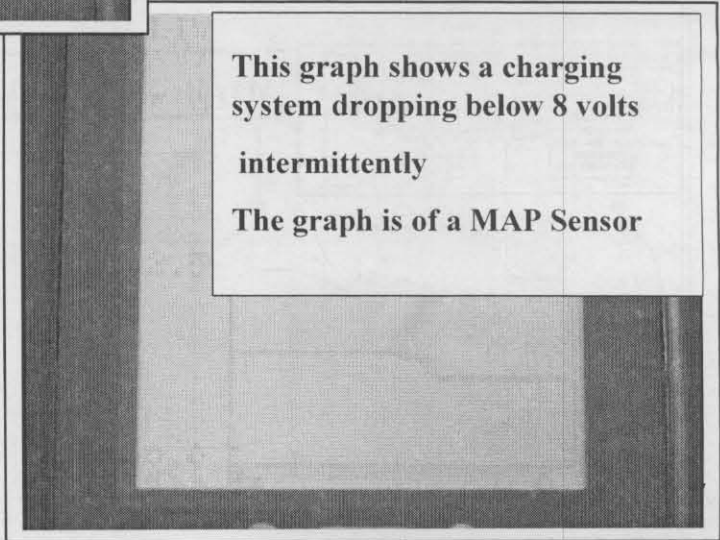

**NOTES:**

---

---

---

---

---

## ENGINE SPEED INPUT

- $RPM \div MAX\ RPM \times MAP \div BARO = LOAD$
- The RPM signal "TELLS" the Computer "WHEN" to add Fuel
- The signal may come from a Distributor or a Crankshaft Sensor

198

The other side of the engine load equation is RPM. The RPM signal tells the PCM when to add fuel. This signal may come from a distributor pickup or a crankshaft sensor.

This is a hall effect type crankshaft sensor used on some Chrysler systems. The slots in the tone wheel define the shape of the crankshaft sensor waveform. The tone wheel is an integral part of the flex plate.

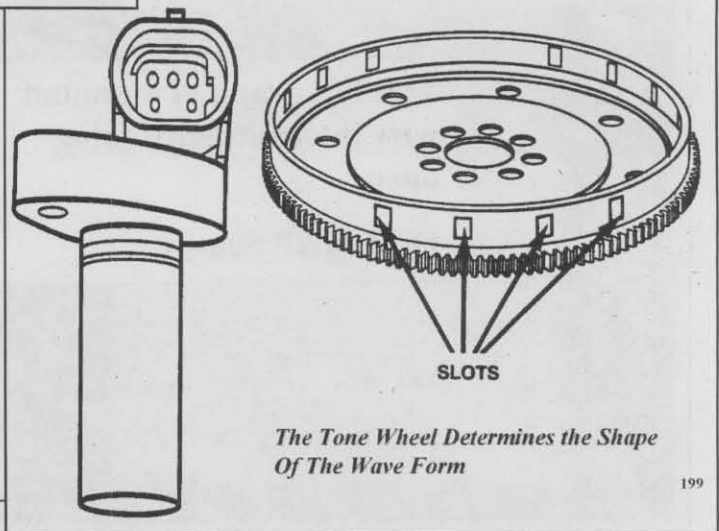

199

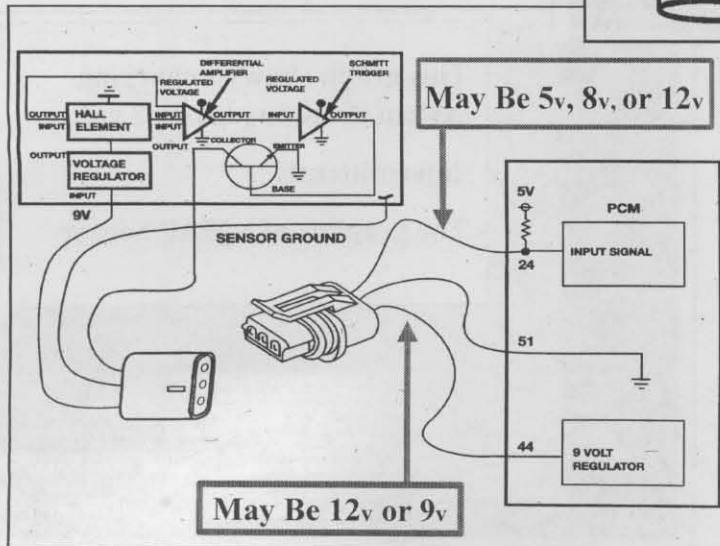

This type of crankshaft sensor is supplied power by the PCM. This power supply will be either 12 volts or 9 volts. The signal returning to the PCM, will be a square wave with either a 5 volt, 8 volt or 12 volt amplitude.

### NOTES:

---



---



---



---



---

Another type of crankshaft sensor is the magnetic or variable reluctance pickup coil. The sensor is made up of a coil winding wrapped around a magnetic core. As the notches in the reluctor wheel pass the tip of the sensor, a voltage is induced into the sensor's coil windings. The PCM reads the amplitude and fre-

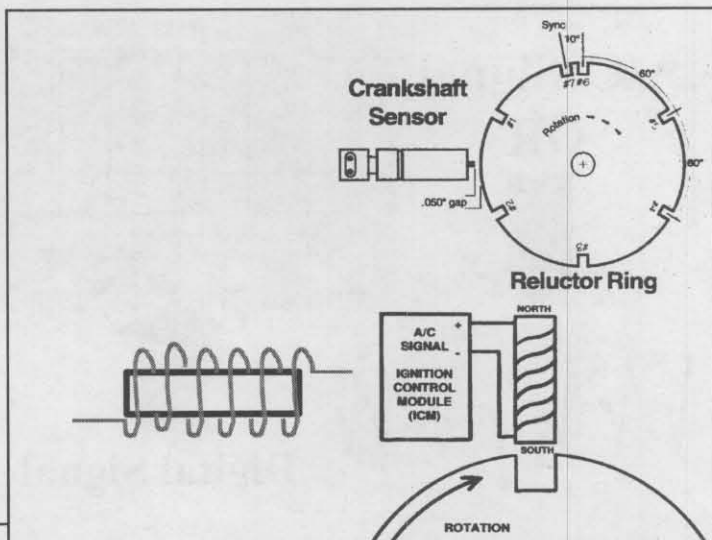

The Signal May Come From A Distributor

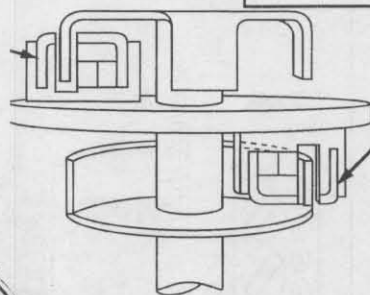
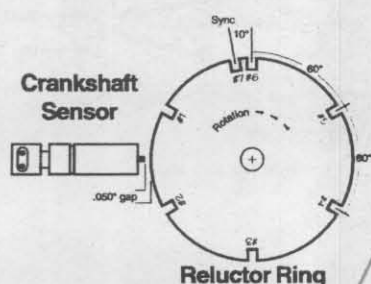

Or  
A Crankshaft Sensor

quency of this signal to determine RPM.

Either type of sensor can be used in a distributor or as a crankshaft sensor.

202

The crankshaft sensor signal is also used by the PCM to identify which cylinders are approaching top dead center.

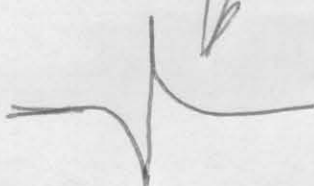

### ENGINE SPEED INPUT

- The RPM signal "TELLS" the Computer "WHEN" to add Fuel *Not how much*
- Anything that affects Fuel will also affect Timing.
- The Engine Speed Sensor signals the Computer the Speed of the Engine as well as which pair of cylinders are coming up to Top Dead Center

203

NOTES:

*Looks like this*

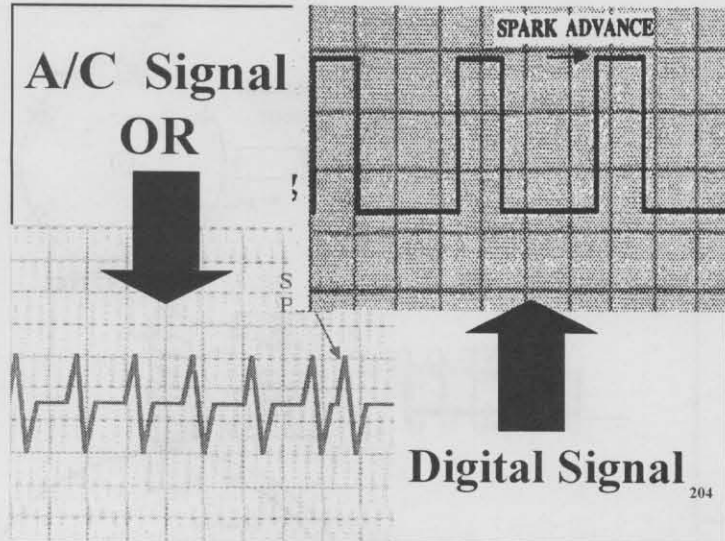

Crankshaft sensor output can come in two forms, analog or digital. The top waveform shown here is a digital square wave. The bottom waveform is an analog AC voltage.

The AC voltage output of a magnetic crankshaft sensor is modified by the ignition module and sent to the PCM as a digital signal. This signal is called distributor, reference on a General Motors vehicle.

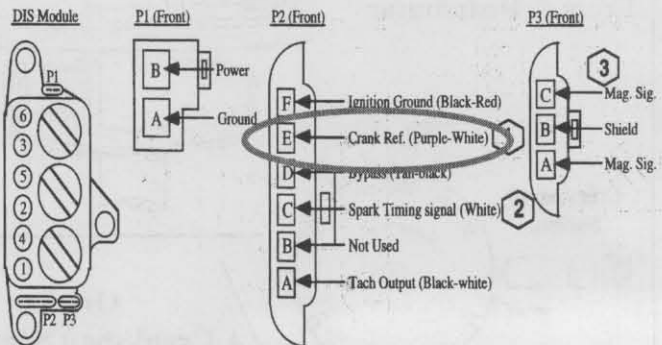

C1-52	TN-BK	Idle: 0.2-0.6 V	Bypass
		Eng Off: 0 V	
C1-53	WT	Idle: 0.2-0.6 V	Signal
		Eng Off: 0 V	
C1-44	PL-WT	Idle: 0.5-0.7 V	3X(-)
		All Conditions:	
C1-45	RD-BK	Under 0.5 V	Crank
		Eng Off: 0 V	
C1-4	LB-BK	Idle: 6.5-7.5 V	Signal
		Eng Off: 0 V	
C1-5	BK	Idle: 0.5-0.7 V	Signal

DIS Module

Engine Speed Sensor

Test Crank Signal into Ignition Module

Test Crank Signal Into Computer

206

When testing the crankshaft sensor, always test the signal from the sensor to the ignition module, as well as the signal from the ignition module to the PCM.

**NOTES:**

---



---



---



---



---

**NOTES:**

---



---



---



---



---



---



---

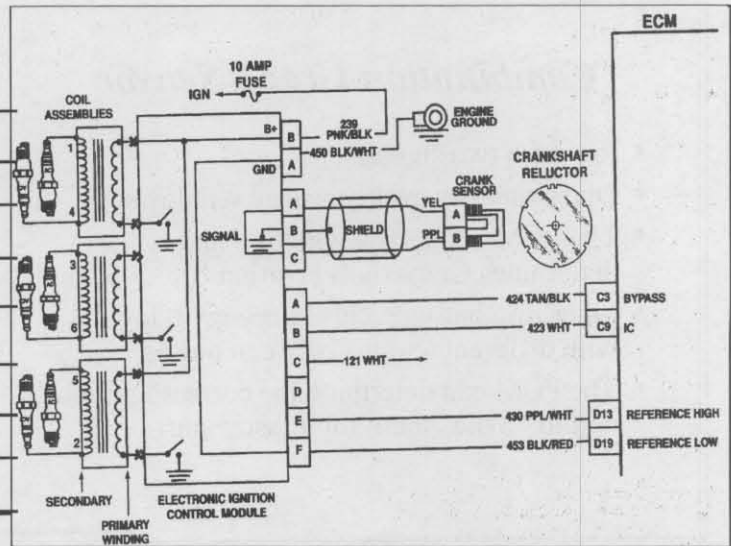

**Camshaft Sensor**

- The Cam Sensor ( if needed ) signals the Computer which cylinder is on the compression stroke

The camshaft sensor signals the PCM as to which cylinder is on the compression stroke. This is an important signal for distributorless ignition coil pack firing, as well as sequential fuel injection.

The General Motor's 3800 fast

208

start system uses a dual crankshaft sensor. The outer ring produces an 18X signal, the inner ring produces a 3X signal. These two signals are used in conjunction by the ignition module, to fire the proper coil for any pair of cylinders on their compression stroke.

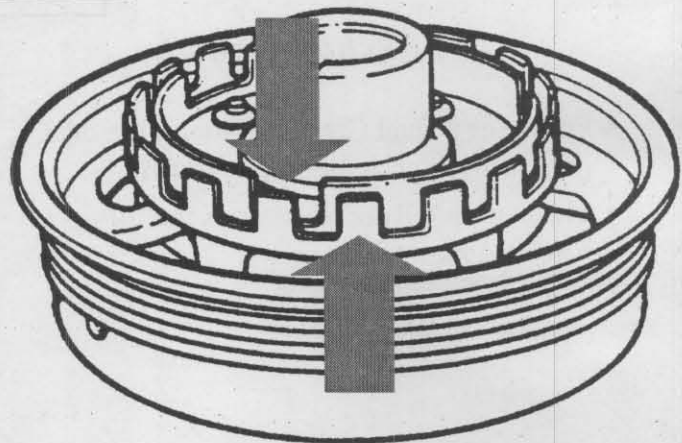

**NOTES:**

---



---



---



---



---

### Combination Crank Sensor

- Provides two signals
- Outer ring has evenly spaced windows
- The PCM counts the windows and determines Crankshaft Position
- Inner ring has unevenly spaced windows with different lengths between pulses
- The PCM can determine the correct ignition coil to “Sync” them for a faster start

210

This type of crankshaft sensor sends two square waves to the ignition module. The 18X signal has a 50% duty cycle. The 3X signal has a varying duty cycle with 10°, 20° and 30° windows spaced at 90°, 100° and 110° apart.

Multi-port fuel injected vehicles can use a crankshaft position sensor to identify number one cylinder top dead center, but not if the cylinder is on the compression or exhaust stroke. This would require a camshaft sensor.

180° Camshaft rotation equals 360° crankshaft rotation

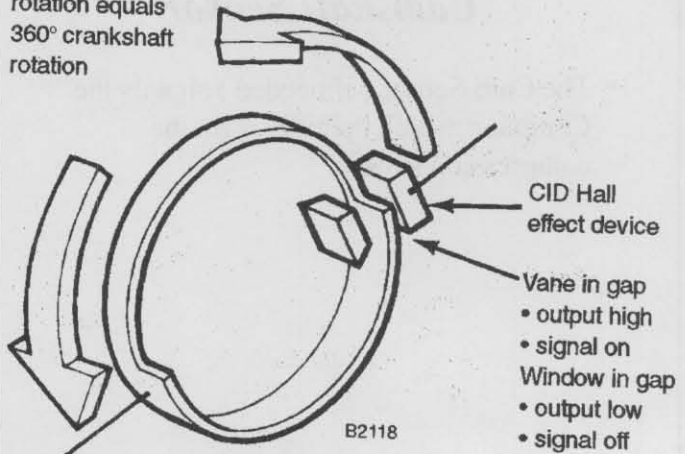

### Crankshaft Sensor

- Ford uses a Dual Crank Sensor on its dual plug distributorless ignition systems.
- The Out Side Ring operates as the PIP — *Profile Ignition Pickup*
- The In Side Ring operates as the CID — *Cylinder Identification*

212

Ford uses a dual crankshaft sensor on its dual plug distributorless ignition system. One half of the sensor is the profile ignition pickup, and the other is the cylinder identification sensor.

### NOTES:

---

---

---

---

---

The PCM makes ignition timing calculations and sends these commands to the ignition module as required. General Motors calls this EST or electronic spark timing. Ford calls this SPOUT or spark output.

### Spark Timing Control

- The computer makes a timing calculation and sends a timing command to the Ignition Module ( if required )
- G.M.'s Timing Command is EST — *Electronic Spark Timing*
- Ford's Timing Command is SPOUT — *Spark Out Put*

213

### Spark Timing Control

- Ignition Module takes the signals from the triggers to control the Current Flow through the Ignition Coils ( Dwell ) by *Grounding* the Primary Circuit
- The Module is responsible for converting the signals, and to limit the current to a specific flow rate, 8amps to 10amps, to prevent damage to the circuit
- Controls timing during cranking and below a certain RPM

The ignition module uses the signals from the crankshaft and camshaft sensors to control current flow through the ignition coils, by grounding the primary circuit. This function is know as dwell. The module is responsible for limiting the primary current to approximately 8-10 amps, to

214

prevent circuit damage. The ignition module controls ignition timing during cranking and at low engine speeds. Once normal engine speed is achieved, the PCM takes over the task of ignition timing control.

### Electronic Spark Timing

C1-52	TN-BK	Idle: 0.2-0.6 V	Bypass
		Eng Off: 0 V	EST
C1-53	WT	Idle: 0.2-0.6 V	Signal
		Eng Off: 0 V	3X(+)
C1-44	PL-WT	Idle: 0.5-0.7 V	DIS Module
		All Conditions: Under 0.5 V	
C1-45	RD-BK	Eng Off: 0 V	Crank
		Eng Off: 0 V	Cam
C1-4	LB-BK	Idle: 6.5-7.5 V	Signal
		Eng Off: 0 V	Cam
C1-5	BK	Idle: 0.5-0.7 V	Signal

When the Engine reaches the Run Threshold, the PCM applies a 5 volt signal to the BY-Pass circuit

This signal turns off the By-Pass and turns on the circuit for Primary Ignition control.

Spark Timing is now controlled By the PCM

215

### NOTES:

---



---



---



---



---



## Ford's Ignition Timing Control

- If the Ignition Module does not receive a signal from the PCM on the SPOUT circuit, the module controls the Spark Timing off of the PIP signal
- After the *Run Threshold* is reached the PCM sends SPOUT signals to the module and controls Spark Timing

216

Ford has a similar function with their ignition modules. If the module does not receive a signal from the PCM on the SPOUT line, the module will control ignition timing based on the PIP signal. Once the run threshold has been reached, the PCM will take over control of ignition timing.

Using a lab scope is the best way to test the ignition timing signals, because it allows the technician to see the entire signal. The lab scope is also the most productive tool as it eliminates multiple tests with other pieces of equipment.

### Testing The Ignition / Injection Control Signals

The Lab Scope is the Best way to "See" and Test these Signals, But not the only way

11.8V VOLTS TO A MAGNETIC TRANSDUCER

#### Distributor Pickup Specifications

Pickup Resistance & AC Volts	
Resistance In $\Omega$	AC Volts At Idle
500-1,500 $\Omega$	2V AC

#### Crank Reference From DIS

Duty Cycle At Idle	DC Voltage At Idle
55-65%	2.5-3.5V

Designed sharper than a Normal A/C to be more Precise  
Signal Peaks Must Be Clean And Even  
( Bushings, Bent Shaft )  
Cranking Voltage Should Be Near 300 mv  
Must be repetitive

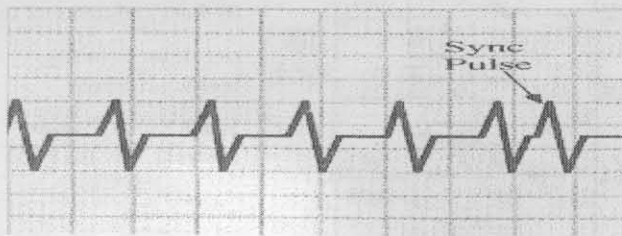

219

The AC voltage waveform from a magnetic crankshaft sensor is designed to have sharper peaks than normal AC voltage. This is intended to allow more precise timing control based off of the signal.

### NOTES:

---



---



---



---

*Watching EST we see it Glitch*

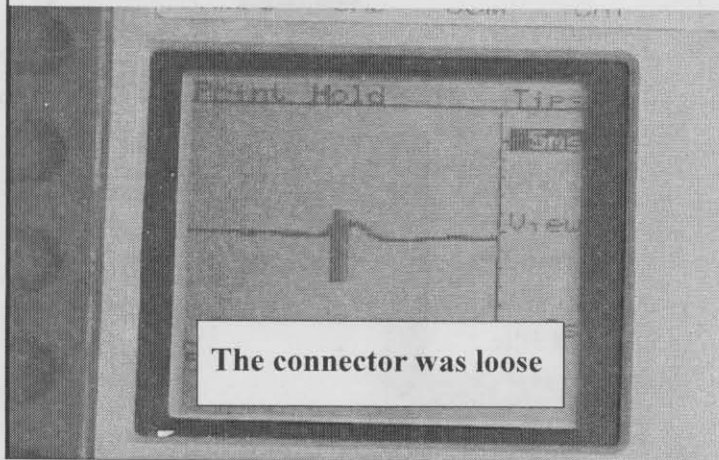

Here is a glitch in an EST signal, caused by a loose connector.

Here is a normal graph of RPM input.

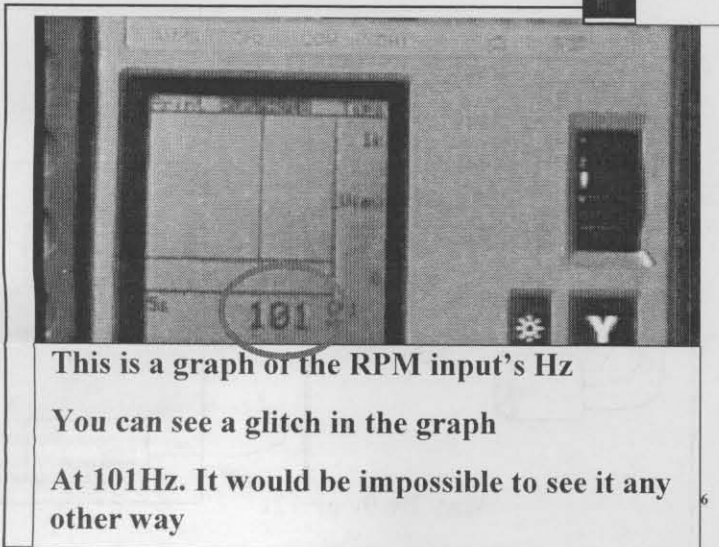
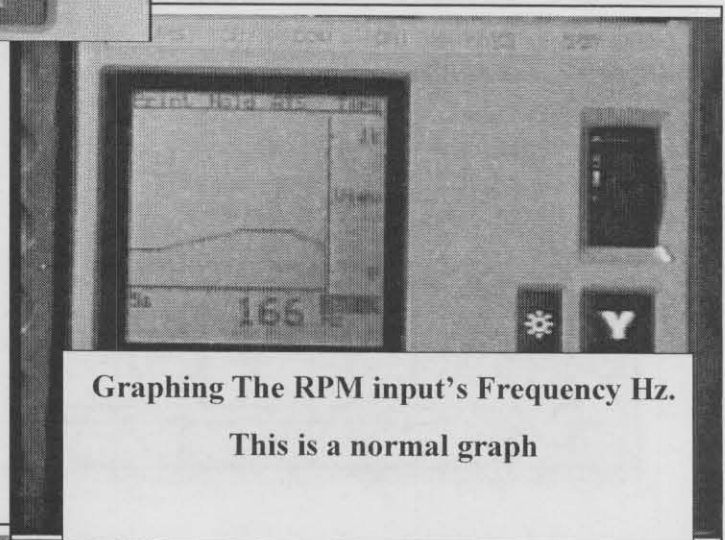

Here is a captured glitch in the RPM signal to the PCM.

**NOTES:** Dont just put new bearings on Honda Distributor that have gone bad the Heat created by the failed bearing will effect the pickup coil wave forms

Mass air-flow sensors offer another way for an engine management system to monitor load. There are two basic types of mass air flow sensors, variable voltage and variable frequency.

**Mass Air Flow Fuel Control Systems**

Air Flow Hz ( Voltage )

\_\_\_\_\_ = **LOAD**

RPM

Two Basic Designs

<u>Frequency Based</u>	<u>Voltage Based</u>
<u>Chrysler = Frequency Based</u>	
<u>Ford = Voltage Based</u>	
<u>G.M. = Both Types</u>	

227

### *Mass Air Flow Sensors*

- Mass Air Flow Sensors measure the amount of air entering the engine
- Measuring the mass of air entering the engine takes into account the temperature and humidity of the air
- MAF Sensors use the principle that the resistance of a conductor varies with temperature
- The changes in the amount of air passing over the heated conductor carries away heat from the conductor

228

Mass air-flow sensors measure the amount of air entering the engine, while taking into account the temperature and density of the air. A mass air-flow sensor contains some type of heated conductor. As air passes through the sensor, some of the

heat is carried away. The sensor attempts to maintain a stable temperature across the heated conductor. The sensor monitors the current necessary to maintain the temperature and this is translated into a MAF signal.

### *Mass Air Flow Sensors*

- More current is required to maintain the temperature of the conductor.
- Humid or denser air is cooler absorbing even more heat
- The current translates into a MAF signal

229

**NOTES:**

---



---



---



---



---

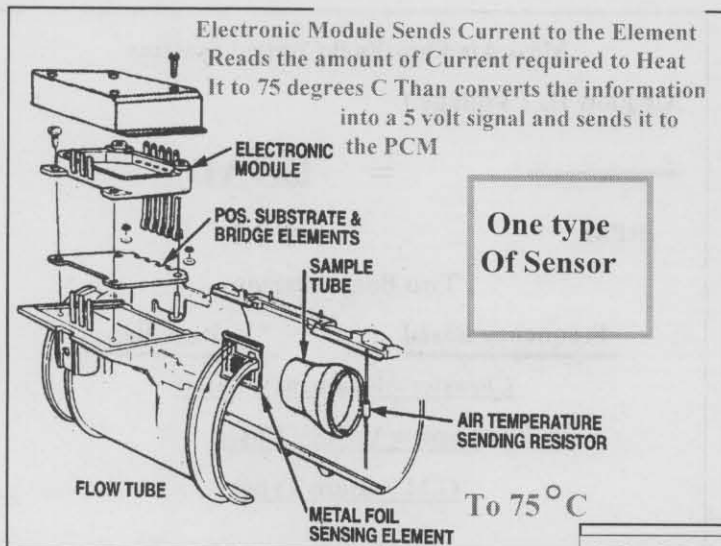

Here is an exploded view of a Delco type mass air-flow sensor.

When reading scan-data, the MAF and AFLO values must stay within two of each other.

The MAF and The AFLO values must stay within two of each other

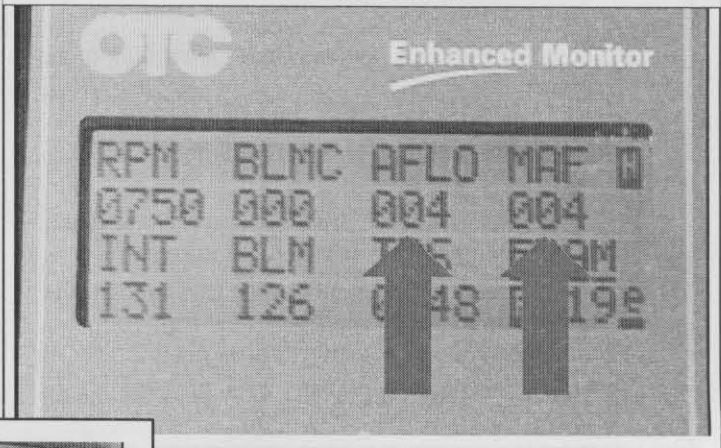

Both MAF And  
AFLO Changed  
Together

The throttle was  
opened  
TPS Voltage  
changed from  
.48v to .50v

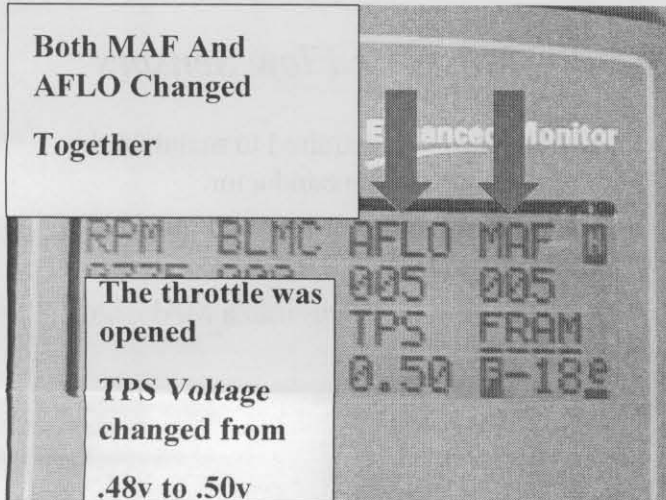

When the throttle is opened, they must change together.

NOTES:

---



---



---



---

Even though the two values are not the same, they are within two of each other.

RPM	BLMC	AFLO	MAF
1075	002	011	012
INT	BLM	TPS	FRAM
128	128	0.76	-17e

The MAF and ALFO are not the same but they are within two of each other

RPM	BLMC	AFLO	MAF
2275	009	046	049
INT	BLM	TPS	FRAM
128	128	1.91	-14e

Here they are not within two of each other  
The MAF is not Calibrated correctly

Here they are not within two of each other. There is a mass air-flow sensor calibration problem.

Here is scan-data displaying a faulty mass air-flow sensor.

RPM	BLMC	AFLO	MAF
3575	011	087	018
INT	BLM	TPS	FRAM
128	128	4.17	-04e

This is where the MAF really Falls apart

**NOTES:**

---



---



---



---



---

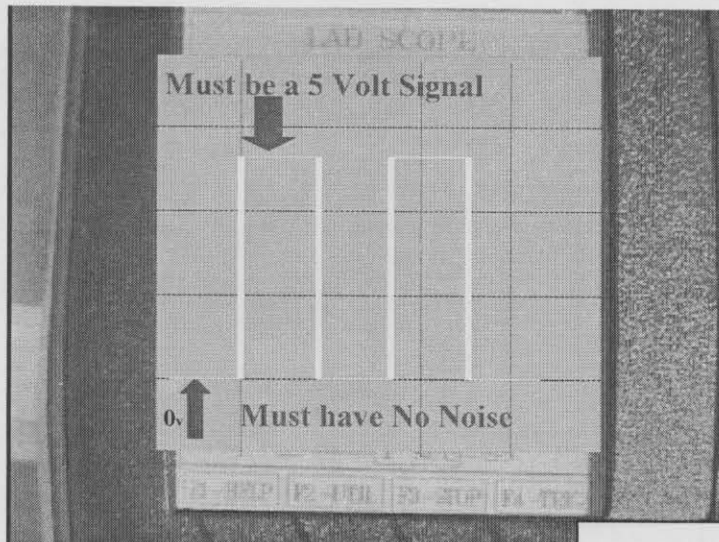

The frequency based mass air-flow sensors must display a good clean square wave on a lab scope. The waveform must also be pulled fully to ground.

Ford uses a variable voltage mass air-flow sensor. The voltage output is vehicle specific.

### FORD

The Sensor is Heated to 200 degrees C Above The Ambient Sensor and the Current required Is converted into a Signal and Sent to The PCM The Voltage Signal is Vehicle Specific

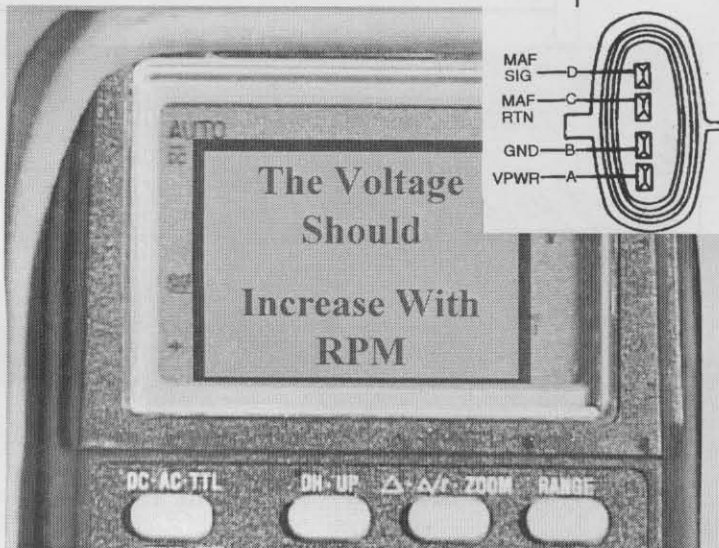
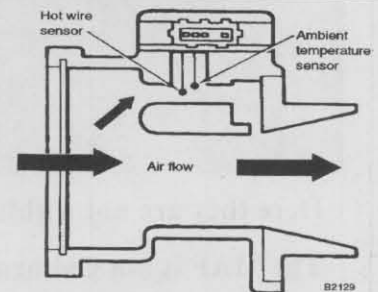

When testing the Ford mass air flow sensor with a digital multi-meter, the voltage should increase smoothly with RPM.

**NOTES:** Ford MAF - Replace MAF Sensor then go and do 4 hard accelerations within 1 Key cycle then recheck Baro if not 144-147 ~~at~~ Replace MAF sensor

Watch the bar graph display on the multi-meter or use the audible tone function to detect glitches.

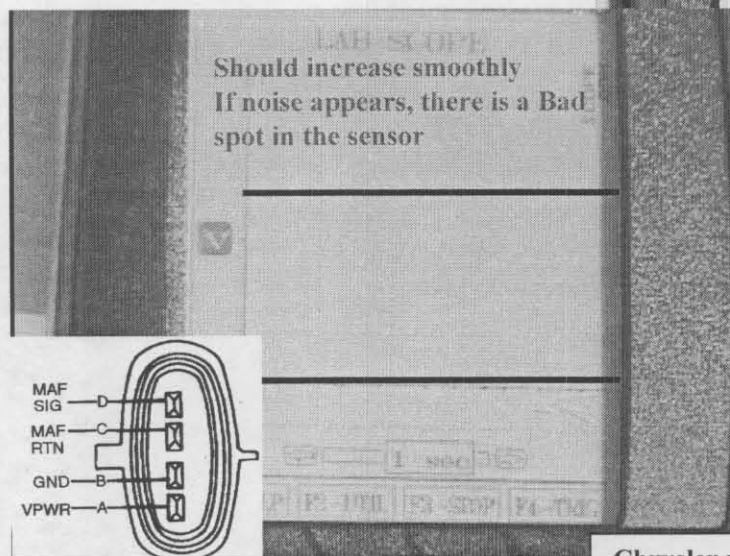
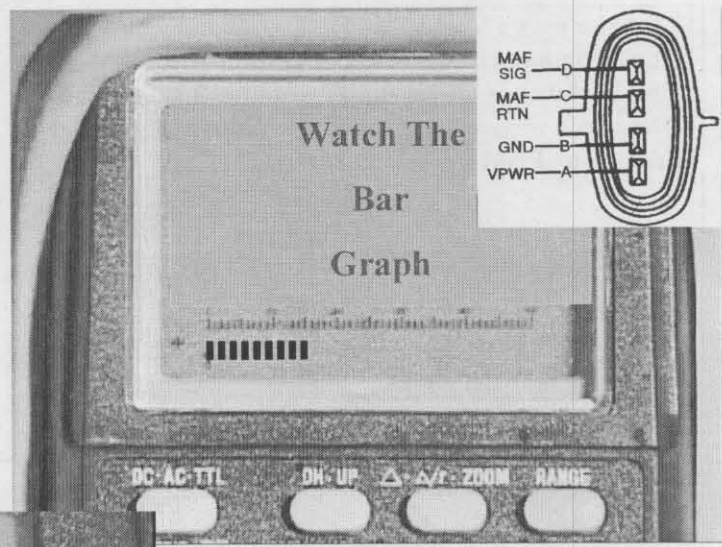

When using a lab scope set to a fast time base, watch for a smooth increase in the sensor output voltage. When using a slower time base, look for the proper signature from a snap throttle test.

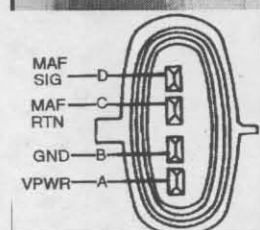

Chrysler uses a pressure type air-flow sensor. A pressure drop caused by the incoming air, is converted into a signal which is sent to the PCM.

**Chrysler uses a Pressure MAF**  
A pressure drop measured from the incoming Air is Converted In to a Signal and Sent to the PCM

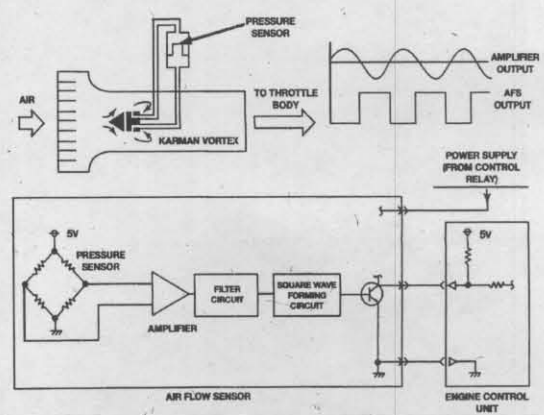

**NOTES:**

---



---



---



---



---

**Chrysler uses a Vortex MAF**

The incoming Air is Swirled around to create a Vortex  
 The Turbulence causes the Transmitter to create the  
 Ultrasonic wave which is converted into a Signal and  
 Sent to the PCM

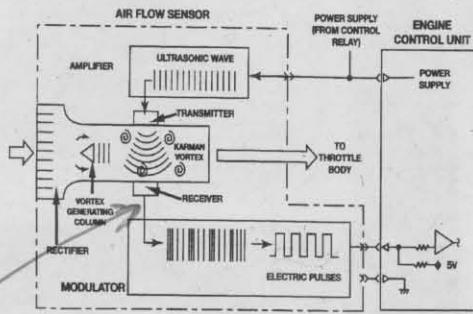

In the Karman Vortex type mass air-flow sensor, incoming air is forced into a vortex which creates an ultrasonic wave. This wave is converted into a signal which is used by the PCM.

The signal is a 5 volt square wave. Check the amplitude of the signal as well as the ground level.

*1 Volt + above 0  
 is OK*

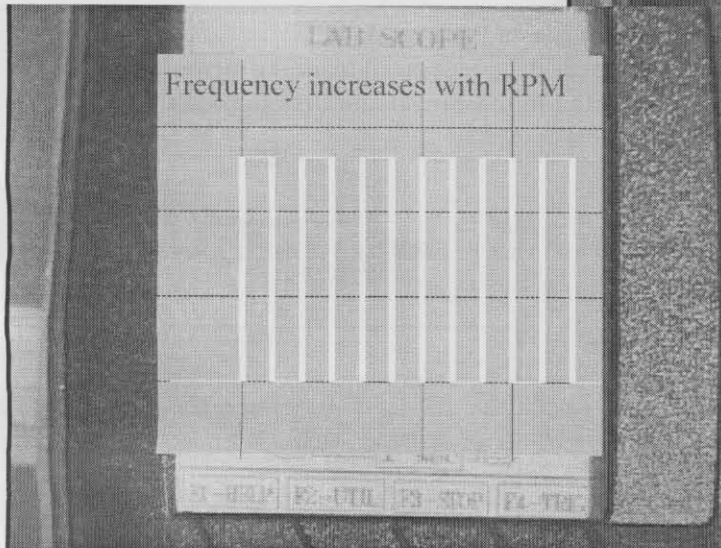
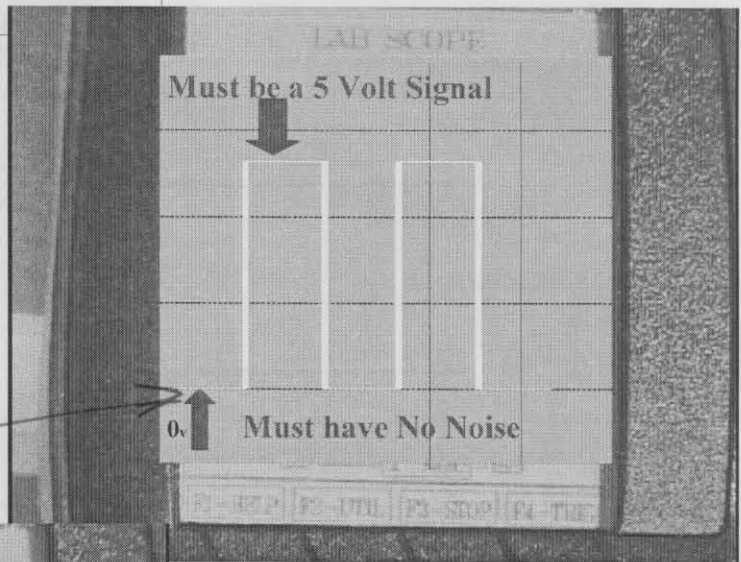

The frequency of the signal must increase with RPM.

**NOTES:**

---



---



---



---



---



Graphing the mass air flow sensor output with a graphing multi-meter is a good way to pinpoint glitches.

### *Graphing MAF Sensors*

- With the Graphing Multi-meter's Glitch Trap connected to the signal wire of the MAF Sensor we Know that it is the MASS AIR FLOW SENSOR that is the problem

254

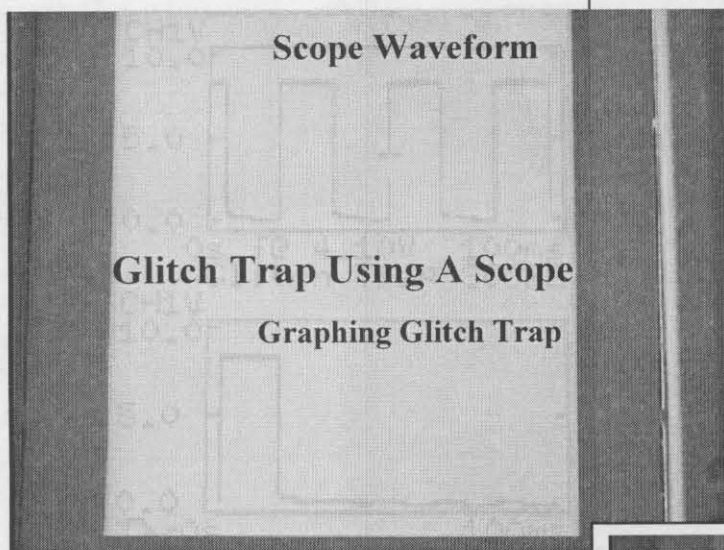

Here is a dual trace display of a lab scope waveform and a graphing meter on the same signal.

Glitches in the waveform are not always caused by the component being tested. Here is a mass air-flow sensor glitch caused by a defective alternator.

**This bump is from the Alternator**  
**This is a graph of a Mass Air Flow Sensor**  
**Charging volts can be graphed with any other signal**

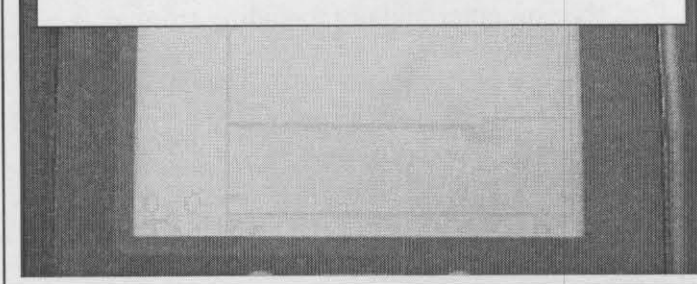

#### **NOTES:**

---

---

---

---

---

## Graphing Scan-Data

- By Graphing DATA from a Scan-Tool we can see the calculated Air Flow Value glitch

257

Scan-tool data can also be graphed to allow us to detect mass air-flow sensor problems.

Here, calculated air-flow values changed for no apparent reason.

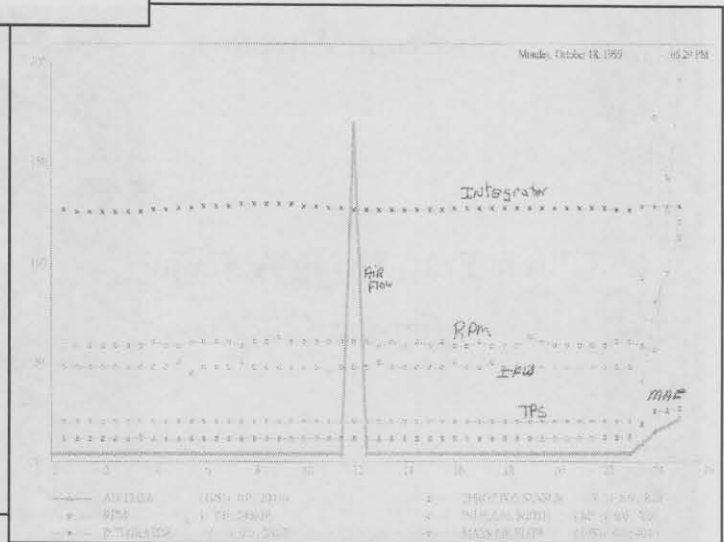

## Calculated Air Flow

- Understand that the Calculated Air Flow reading is data displayed by the computer on the Scan-Tool after it was calculated by the computer and not a reading from a sensor

259

Because this is a PCM calculation and not an actual input, we must look more closely at the PCM.

## NOTES:

---

---

---

---

---

We start by graphing powers and ground at the same time we graph scan-data.

### *Calculated Air Flow*

- Because the computer must be powered and grounded correctly in order to perform it's function of calculating we will want to graph the computer's powers and grounds at the same time we graph the Calculated Air Flow Value.

260

### *Calculated Air Flow*

- The DATA Graph on the previous page was from a bad computer.
- That was determined by the Powers and grounds not glitching when the Air Flow Value glitched.

261

Once the glitch appeared again and there were no anomalies in the powers or grounds, the PCM was determined to be faulty.

Chrysler uses a barometric pressure sensor built into the mass air-flow sensor. This sensor is used by the PCM to modify injector pulse width based on changes in barometric pressure.

### *Chrysler MAF Sensor*

- Chrysler uses a Barometric Pressure Sensor built into their MAF
- The Sensor Signal is used by the PCM to reduce or increase the IPW to compensate for Barometric Pressure changes
- The Sensor can change the IPW by
  - 50 % Reduction
  - 12.5 % Increase

262

#### **NOTES:**

---

---

---

---

---